



**Factory**

Cuijia, Xidian Town, Ninghai, Ningbo,  
China 315613  
Tel: +86-574-65181812  
+86-574-65171366  
E-mail: sales1@yingjiao.com

**Global Export Office**

Dongcheng International, 155 Xinhui Road,  
Ningbo, Zhejiang, China  
Tel: +86-574-87563855  
+86-574-87127889  
E-mail: sales2@yingjiao.com

**US Branch**

Elwood IN 46036, USA  
E-mail: us@yingjiao.com  
www.yingjiao.us

**EU Branch**

Grumbkowstrasse 65A 13156 Berlin Germany  
E-mail: sales-eu@yingjiao.com

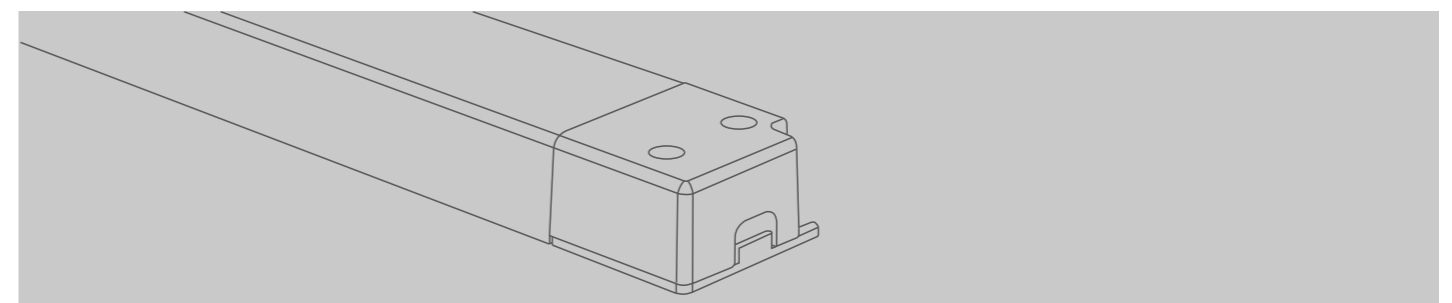
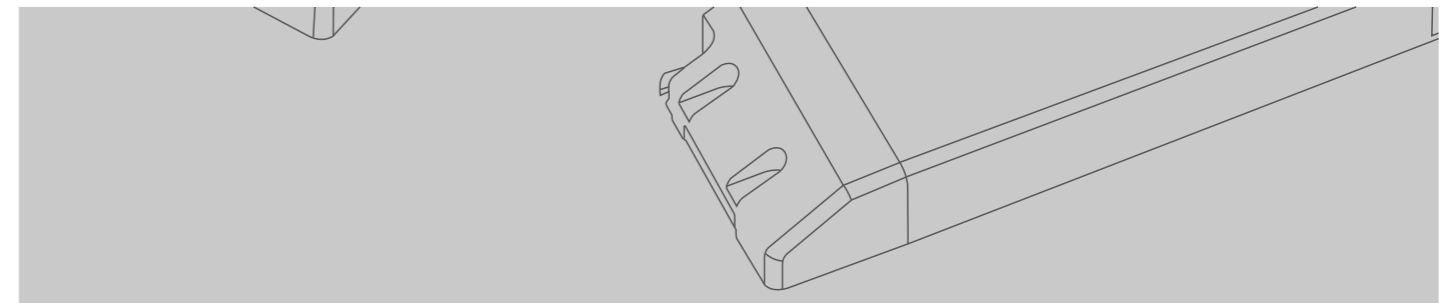

## WELCOME Our Company

---

Yingjiao Electrical Co.,Ltd. was established in 1995 and is dedicated to the design and development of all types of low voltage power adapters, LED drivers, utilizing scaled manufacturing and global sales to fully serve the world's electronic and electric industries. The core products include switching & linear power adapters, battery chargers, transformers, DIN rail power supply, enclosed power supplies, medical power supplies, LED drivers and completely customizable power solutions, designed for use in telecommunications, IT equipment, consumer electronic devices, security system, automation, medical equipments, smart home, LED lights and much more.

Yingjiao committed to total quality management through continuing improvement processes, including derating & reliability analytics testing, MTBF procedures are an integral part of our research and development, with quality assurance management in support of ISO9001, ISO1400 quality systems ensure that Yingjiao consistently offers the highest quality products for our customers.

Yingjiao products comply with RoHS, PAHS, REACH and WEEE standards, Achieve CoCV5 and DoE VI of efficiency level, obtained and maintained UL, cUL, FCC, TUV-GS, CB, CSA, PSE, RCM, KC, EAC, CE, EMC and CCC safety certificates.

In addition to our full line of products, Yingjiao is able to offer complete ODM/OEM product development to meet the individual requirements of our business partners.

### Yingjiao Values

Yingjiao is committed to becoming your premier power supply partner. With unsurpassed customer service and professionalism, Yingjiao is uniquely suited to deliver market leading power supplies and LED drivers to meet your own specific requirements.

## TABLE OF Contents

---

<b>Standard Series</b>	<b>01</b>
<b>IP20 Super Thin Series</b>	<b>18</b>
<b>Cabinet Light Series</b>	<b>26</b>
<b>LineType Series</b>	<b>37</b>
<b>IP44 Super Thin Series</b>	<b>43</b>
<b>Waterproof Series</b>	<b>49</b>
<b>Dimmable Series</b>	<b>67</b>
<b>DALI Dimming Series</b>	<b>68</b>
<b>LINEAGE Series</b>	<b>87</b>
<b>0-10V Dimming Series</b>	<b>91</b>
<b>Programmable 0-10V Series</b>	<b>93</b>
<b>Tri-Mode Dimming Series</b>	<b>95</b>
<b>Low Profile Enclosed Series</b>	<b>99</b>
<b>Enclosed Series</b>	<b>101</b>

**YLE-8 Series**

**220-240V AC**  
Input Voltage

**50/60Hz**  
Input Frequency

**8W**  
Rated Power



- Safety standard: EN61347-1, EN61347-2-13,
- EMI standard: EN55015
- EMS standard: EN61547
- ERP: EU2019/2020
- Protection: Short Circuit/Overload/Over Voltage/Over Temperature
- 100% full load burn in test
- Auto restart after remove of fault conditions
- RoHS Compliance
- IP20

**Dimensions (mm)**

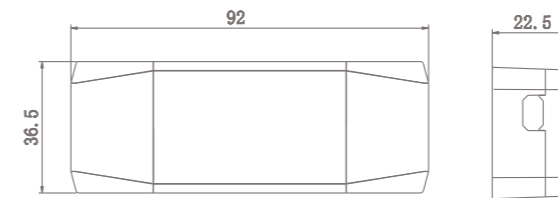

**Standard**  
LED Power Supply

**8W-320W**

**Constant Current**

Model	Power (max.)	Input Voltage	Output Current	Output Voltage (max.)	Voltage Tolerance	Efficiency	Dimensions (LxWxH)
YEL-8-150	8W	220-240V AC	150mA	53V	± 5%	85%	92x36.5x22.5mm
YEL-8-200	8W	220-240V AC	200mA	40V	± 5%	85%	92x36.5x22.5mm
YEL-8-250	8W	220-240V AC	250mA	32V	± 5%	85%	92x36.5x22.5mm

## YLE-12 Series



**220-240V AC**  
Input Voltage

**50/60Hz**  
Input Frequency

**12W**  
Rated Power

- Safety standard: EN61347-1, EN61347-2-13,
- EMI standard: EN55015
- EMS standard: EN61547
- ERP: EU2019/2020
- Protection: Short Circuit/Overload/Over Voltage/Over Temperature
- 100% full load burn in test
- Auto restart after remove of fault conditions
- RoHS Compliance
- IP20

### Dimensions (mm)

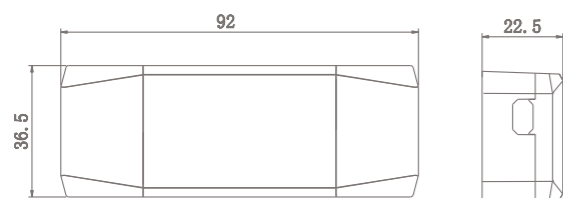

### Constant Current

Model	Power (max.)	Input Voltage	Output Current	Output Voltage (max.)	Voltage Tolerance	Efficiency	Dimensions (LxWxH)
YEL-12-250	12W	220-240V AC	250mA	48V	± 5%	85%	92x36.5x22.5mm
YEL-12-300	12W	220-240V AC	300mA	40V	± 5%	85%	92x36.5x22.5mm
YEL-12-350	12W	220-240V AC	350mA	34V	± 5%	85%	92x36.5x22.5mm
YEL-12-500	12W	220-240V AC	500mA	24V	± 5%	85%	92x36.5x22.5mm
YEL-12-600	12W	220-240V AC	600mA	20V	± 5%	85%	92x36.5x22.5mm

## YLE -40 Series



**220-240V AC**  
Input Voltage

**50/60Hz**  
Input Frequency

**40W**  
Rated Power

- Safety standard: EN61347-1, EN61347-2-13,
- EMI standard: EN55015
- EMS standard: EN61547
- ERP: EU2019/2020
- Protection: Short Circuit/Overload/Over Voltage/Over Temperature
- 100% full load burn in test
- Auto restart after remove of fault conditions
- RoHS Compliance
- IP20

### Dimensions (mm)

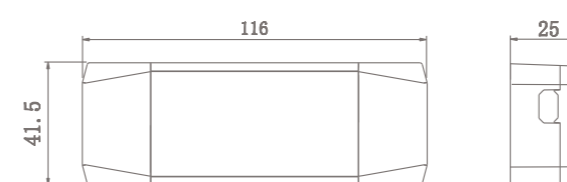

### Constant Current

Model	Power (max.)	Input Voltage	Output Current	Output Voltage (max.)	Voltage Tolerance	Efficiency	Dimensions (LxWxH)
YEL-40-500	40W	220-240V AC	500mA	80V	± 5%	85%	118x41.5x25mm
YEL-40-600	40W	220-240V AC	600mA	66V	± 5%	85%	118x41.5x25mm
YEL-40-700	40W	220-240V AC	700mA	57V	± 5%	85%	118x41.5x25mm
YEL-40-800	40W	220-240V AC	800mA	50V	± 5%	85%	118x41.5x25mm
YEL-40-900	40W	220-240V AC	900mA	44V	± 5%	85%	118x41.5x25mm
YEL-40-1050	40W	220-240V AC	1050mA	38V	± 5%	85%	118x41.5x25mm

## YLD20 Series

Adjustable 12/24V

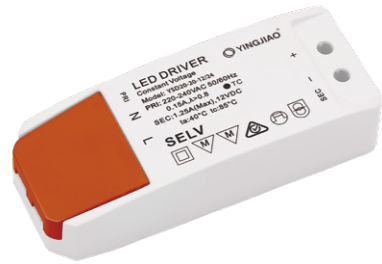

**220-240V AC**  
Input Voltage

**50/60Hz**  
Input Frequency

**20W**  
Rated Power

- Output Voltage Adjustable
- Safety standard: EN61347-1, EN61347-2-13,
- EMI standard: EN55015
- EMS standard: EN61547
- ERP: EU2019/2020
- Protection: Short Circuit/Overload/Over Voltage/Over Temperature
- 100% full load burn in test
- Auto restart after remove of fault conditions
- RoHS Compliance
- IP20

### Dimensions (mm)

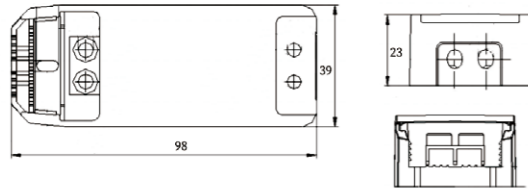

### Constant Voltage

Model	Power (max.)	Input Voltage	Output Voltage	Output Current (max.)	PF	Voltage Tolerance	Efficiency	Dimensions (LxWxH)
YSD20-15	15W	220-240V AC	12V/24V	1.25A/0.75A	≥ 0.9	± 5%	85%	98x39x23mm
YSD20-20	20W	220-240V AC	12V/24V	1.66A/0.83A	≥ 0.9	± 5%	85%	98x39x23mm

## YLD40 Series

Adjustable 12/24V



**220-240V AC**  
Input Voltage

**50/60Hz**  
Input Frequency

**40W**  
Rated Power

- Safety standard: EN61347-1, EN61347-2-13,
- EMI standard: EN55015
- EMS standard: EN61547
- ERP: EU2019/2020
- Protection: Short Circuit/Overload/Over Voltage/Over Temperature
- 100% full load burn in test
- Auto restart after remove of fault conditions
- RoHS Compliance
- IP20

### Dimensions (mm)

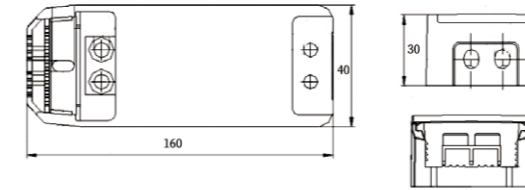

### Constant Voltage

Model	Power (max.)	Input Voltage	Output Voltage	Output Current (max.)	PF	Voltage Tolerance	Efficiency	Dimensions (LxWxH)
YSD40-30	30W	220-240V AC	12V/24V	2.5A/1.25A	≥ 0.9	± 5%	88%	160x40x30mm
YSD40-40	40W	220-240V AC	12V/24V	3.33A/1.66A	≥ 0.9	± 5%	88%	160x40x30mm

## YLD60 Series

Adjustable 12/24V



**220-240V AC**  
Input Voltage

**50/60Hz**  
Input Frequency

**60W**  
Rated Power

- Safety standard: EN61347-1, EN61347-2-13,
- EMI standard: EN55015
- EMS standard: EN61547
- ERP: EU2019/2020
- Protection: Short Circuit/Overload/Over Voltage/Over Temperature
- 100% full load burn in test
- Auto restart after remove of fault conditions
- RoHS Compliance
- IP20

### Dimensions (mm)

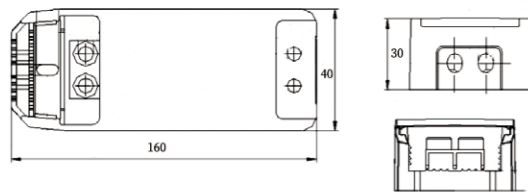

### Constant Voltage

Model	Power (max.)	Input Voltage	Output Voltage	Output Current (max.)	PF	Voltage Tolerance	Efficiency	Dimensions (LxWxH)
YSD60-60	60W	220-240V AC	12V/24V	5A/2.5A	≥ 0.9	± 5%	88.5%	160x40x30mm

## YSL12 Series



**220-240V AC**  
Input Voltage

**50/60Hz**  
Input Frequency

**12/15W**  
Rated Power

- Safety standard: EN61347-1, EN61347-2-13,
- EMI standard: EN55015
- EMS standard: EN61547
- ERP: EU2019/2020
- Protection: Short Circuit/Overload/Over Voltage/Over Temperature
- 100% full load burn in test
- Auto restart after remove of fault conditions
- RoHS Compliance
- IP20

### Dimensions (mm)

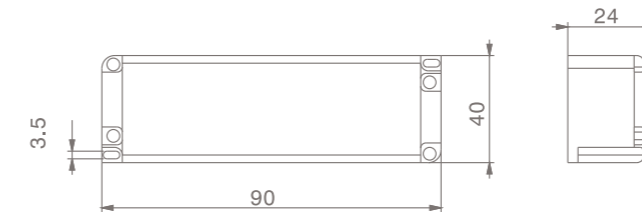

### Constant Voltage

Model	Power (max.)	Input Voltage	Output Voltage	Output Current (max.)	Voltage Tolerance	Ripple (P-P)	Efficiency	Dimensions (LxWxH)
YSL12-12	15W	220-240V AC	12V	1.25A	± 5%	< 1%	85%	90x40x24mm
YSL12-24	15W	220-240V AC	24V	0.625A	± 5%	< 1%	85%	90x40x24mm

### Constant Current

Model	Power (max.)	Input Voltage	Output Current	Output Voltage (max.)	Voltage Tolerance	Efficiency	Dimensions (LxWxH)
YSL12-350	12W	220-240V AC	350mA	34V	± 5%	85%	90x40x24mm
YSL12-500	12W	220-240V AC	500mA	24V	± 5%	85%	90x40x24mm
YSL12-700	12W	220-240V AC	700mA	17V	± 5%	85%	90x40x24mm

## YSL15 Series



**220-240V AC** Input Voltage  
**50/60Hz** Input Frequency  
**15/20W** Rated Power

- Safety standard: EN61347-1, EN61347-2-13,
- EMI standard: EN55015
- EMS standard: EN61547
- ERP: EU2019/2020
- Protection: Short Circuit/Overload/Over Voltage/Over Temperature
- 100% full load burn in test
- Auto restart after remove of fault conditions
- RoHS Compliance
- IP20

### Dimensions (mm)

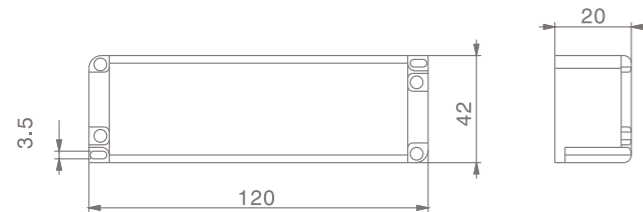

### Constant Voltage

Model	Power (max.)	Input Voltage	Output Voltage	Output Current (max.)	Voltage Tolerance	Ripple (P-P)	Efficiency	Dimensions (LxWxH)
YSL15-12	20W	220-240V AC	12V	1.67A	± 5%	< 1%	88%	120x42x20mm
YSL15-24	20W	220-240V AC	24V	0.83A	± 5%	< 1%	88%	120x42x20mm

### Constant Current

Model	Power (max.)	Input Voltage	Output Current	Output Voltage (max.)	Voltage Tolerance	Efficiency	Dimensions (LxWxH)
YSL15-350	20W	220-240V AC	350mA	57V	± 5%	88%	120x42x20mm
YSL15-500	20W	220-240V AC	500mA	40V	± 5%	88%	120x42x20mm
YSL15-700	20W	220-240V AC	700mA	28V	± 5%	88%	120x42x20mm

## YSL30 Series



**220-240V AC** Input Voltage  
**50/60Hz** Input Frequency  
**30/36W** Rated Power

- Safety standard: EN61347-1, EN61347-2-13,
- EMI standard: EN55015
- EMS standard: EN61547
- ERP: EU2019/2020
- Protection: Short Circuit/Overload/Over Voltage/Over Temperature
- 100% full load burn in test
- Auto restart after remove of fault conditions
- RoHS Compliance
- IP20

### Dimensions (mm)

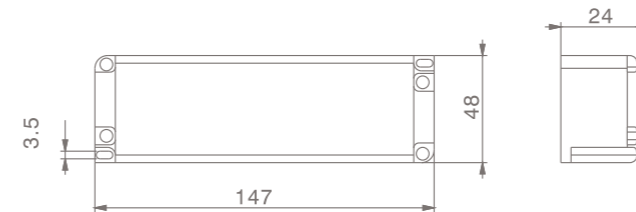

### Constant Voltage

Model	Power (max.)	Input Voltage	Output Voltage	Output Current (max.)	PF	Voltage Tolerance	Efficiency	Dimensions (LxWxH)
YSL30-12	36W	220-240V AC	12V	3A	≥ 0.9	± 5%	88%	147x48x24mm
YSL30-24	36W	220-240V AC	24V	1.5A	≥ 0.9	± 5%	88%	147x48x24mm

### Constant Current

Model	Power (max.)	Input Voltage	Output Current	Output Voltage (max.)	Voltage Tolerance	Efficiency	Dimensions (LxWxH)
YSL30-700	36W	220-240V AC	700mA	51V	± 5%	88%	147x48x24mm
YSL30-1050	36W	220-240V AC	1050mA	34V	± 5%	88%	147x48x24mm
YSL30-1400	36W	220-240V AC	1400mA	25V	± 5%	88%	147x48x24mm

## YSL36 Series



**220-240V AC** Input Voltage      **50/60Hz** Input Frequency      **36W** Rated Power

- Safety standard: EN61347-1, EN61347-2-13,
- EMI standard: EN55015
- EMS standard: EN61547
- ERP: EU2019/2020
- Protection: Short Circuit/Overload/Over Voltage/Over Temperature
- 100% full load burn in test
- Auto restart after remove of fault conditions
- RoHS Compliance
- IP20

### Dimensions (mm)

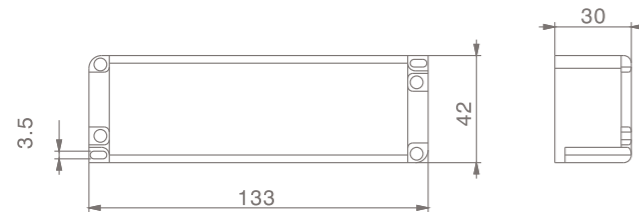

### Constant Voltage

Model	Power (max.)	Input Voltage	Output Voltage	Output Current (max.)	PF	Voltage Tolerance	Efficiency	Dimensions (LxWxH)
YSL36-12	36W	220-240V AC	12V	3A	≥0.9	±5%	88%	133x42x30mm
YSL36-24	36W	220-240V AC	24V	1.5A	≥0.9	±5%	88%	133x42x30mm

### Constant Current

Model	Power (max.)	Input Voltage	Output Current	Output Voltage (max.)	PF	Voltage Tolerance	Efficiency	Dimensions (LxWxH)
YSL36-500	36W	220-240V AC	500mA	72V	≥0.9	±5%	88%	133x42x30mm
YSL36-700	36W	220-240V AC	700mA	51V	≥0.9	±5%	88%	133x42x30mm
YSL36-1050	36W	220-240V AC	1050mA	34V	≥0.9	±5%	88%	133x42x30mm

## YSL40 Series



**220-240V AC** Input Voltage      **50/60Hz** Input Frequency      **40W** Rated Power

- Safety standard: EN61347-1, EN61347-2-13,
- EMI standard: EN55015
- EMS standard: EN61547
- ERP: EU2019/2020
- Protection: Short Circuit/Overload/Over Voltage/Over Temperature
- 100% full load burn in test
- Auto restart after remove of fault conditions
- RoHS Compliance
- IP20

### Dimensions (mm)

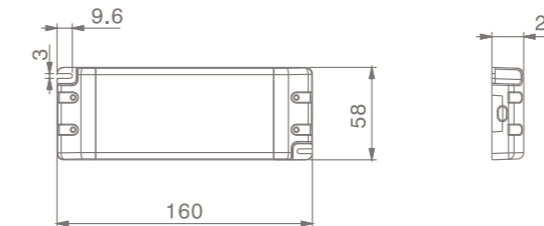

### Constant Voltage

Model	Power (max.)	Input Voltage	Output Voltage	Output Current (max.)	PF	Voltage Tolerance	Efficiency	Dimensions (LxWxH)
YSL40-12	40W	220-240V AC	12V	3.33A	≥0.9	±5%	88%	160x58x20mm
YSL40-24	40W	220-240V AC	24V	1.66A	≥0.9	±5%	88%	160x58x20mm

### Constant Current

Model	Power (max.)	Input Voltage	Output Current	Output Voltage (max.)	PF	Voltage Tolerance	Efficiency	Dimensions (LxWxH)
YSL40-500	40W	220-240V AC	500mA	80V	≥0.9	±5%	88%	160x58x20mm
YSL40-700	40W	220-240V AC	700mA	57V	≥0.9	±5%	88%	160x58x20mm
YSL40-1050	40W	220-240V AC	1050mA	28.5V	≥0.9	±5%	88%	160x58x20mm



## YSL60 Series



**220-240V AC** Input Voltage  
**50/60Hz** Input Frequency  
**60W** Rated Power

- Safety standard: EN61347-1, EN61347-2-13,
- EMI standard: EN55015
- EMS standard: EN61547
- ERP: EU2019/2020
- Protection: Short Circuit/Overload/Over Voltage/Over Temperature
- 100% full load burn in test
- Auto restart after remove of fault conditions
- RoHS Compliance
- IP20

### Dimensions (mm)

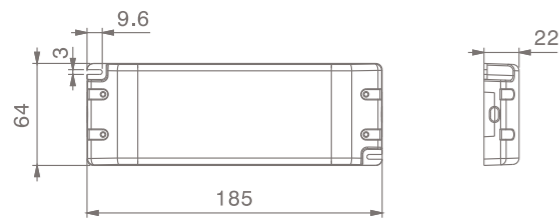

### Constant Voltage

Model	Power (max.)	Input Voltage	Output Voltage	Output Current (max.)	PF	Voltage Tolerance	Efficiency	Dimensions (LxWxH)
YSL60-12	60W	220-240V AC	12V	5A	≥ 0.9	± 5%	92%	185x64x22mm
YSL60-24	60W	220-240V AC	24V	2.5A	≥ 0.9	± 5%	92%	185x64x22mm
YSL60-36	60W	220-240V AC	36V	1.66A	≥ 0.9	± 5%	92%	185x64x22mm
YSL60-48	60W	220-240V AC	48V	1.25A	≥ 0.9	± 5%	92%	185x64x22mm

### Constant Current

Model	Power (max.)	Input Voltage	Output Current	Output Voltage (max.)	PF	Voltage Tolerance	Efficiency	Dimensions (LxWxH)
YSL60-700	60W	220-240V AC	700mA	85V	≥ 0.9	± 5%	92%	185x64x22mm
YSL60-1050	60W	220-240V AC	1050mA	57V	≥ 0.9	± 5%	92%	185x64x22mm
YSL60-1400	60W	220-240V AC	1400mA	42.8V	≥ 0.9	± 5%	92%	185x64x22mm

## YSL80 Series



**220-240V AC** Input Voltage  
**50/60Hz** Input Frequency  
**72/80W** Rated Power

- Safety standard: EN61347-1, EN61347-2-13,
- EMI standard: EN55015
- EMS standard: EN61547
- ERP: EU2019/2020
- Protection: Short Circuit/Overload/Over Voltage/Over Temperature
- 100% full load burn in test
- Auto restart after remove of fault conditions
- RoHS Compliance
- IP20

### Dimensions (mm)

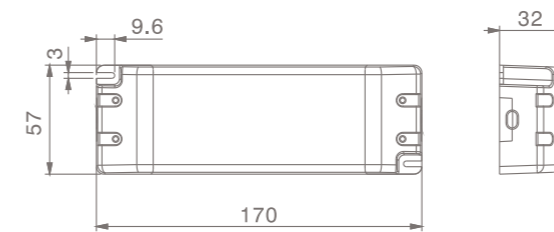

### Constant Voltage

Model	Power (max.)	Input Voltage	Output Voltage	Output Current (max.)	PF	Voltage Tolerance	Efficiency	Dimensions (LxWxH)
YSL80-12	80W	220-240V AC	12V	6.67A	≥ 0.9	± 5%	90%	170x57x32mm
YSL80-24	80W	220-240V AC	24V	3.33A	≥ 0.9	± 5%	90%	170x57x32mm
YSL80-36	80W	220-240V AC	36V	2.22A	≥ 0.9	± 5%	90%	170x57x32mm
YSL80-48	80W	220-240V AC	48V	1.66A	≥ 0.9	± 5%	90%	170x57x32mm

### Constant Current

Model	Power (max.)	Input Voltage	Output Current	Output Voltage (max.)	PF	Voltage Tolerance	Efficiency	Dimensions (LxWxH)
YSL80-1050	80W	220-240V AC	1050mA	76V	≥ 0.9	± 5%	92%	170x57x32mm
YSL80-1400	80W	220-240V AC	1400mA	57V	≥ 0.9	± 5%	92%	170x57x32mm
YSL80-2100	80W	220-240V AC	2100mA	38V	≥ 0.9	± 5%	92%	170x57x32mm

## YSL100 Series



**220-240V AC** Input Voltage  
**50/60Hz** Input Frequency  
**100W** Rated Power

- Safety standard: EN61347-1, EN61347-2-13,
- EMI standard: EN55015
- EMS standard: EN61547
- ERP: EU2019/2020
- Protection: Short Circuit/Overload/Over Voltage/Over Temperature
- 100% full load burn in test
- Auto restart after remove of fault conditions
- RoHS Compliance
- IP20

### Dimensions (mm)

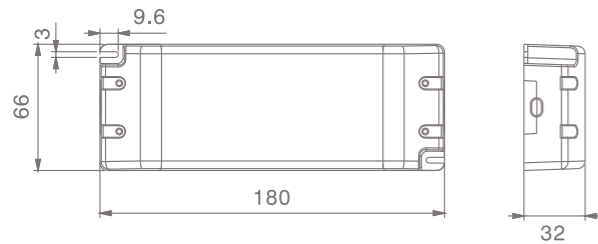

### Constant Voltage

Model	Power (max.)	Input Voltage	Output Voltage	Output Current (max.)	PF	Voltage Tolerance	Efficiency	Dimensions (LxWxH)
YSL100-12	100W	220-240V AC	12V	8.33A	≥ 0.95	± 5%	92%	180x66x32mm
YSL100-24	100W	220-240V AC	24V	4.16A	≥ 0.95	± 5%	92%	180x66x32mm
YSL100-36	100W	220-240V AC	36V	2.77A	≥ 0.95	± 5%	92%	180x66x32mm
YSL100-48	100W	220-240V AC	48V	2.08A	≥ 0.95	± 5%	92%	180x66x32mm

## YSL150 Series



**220-240V AC** Input Voltage  
**50/60Hz** Input Frequency  
**150/200W** Rated Power

- Safety standard: EN61347-1, EN61347-2-13,
- EMI standard: EN55015
- EMS standard: EN61547
- ERP: EU2019/2020
- Protection: Short Circuit/Overload/Over Voltage/Over Temperature
- 100% full load burn in test
- Auto restart after remove of fault conditions
- RoHS Compliance
- IP20

### Dimensions (mm)

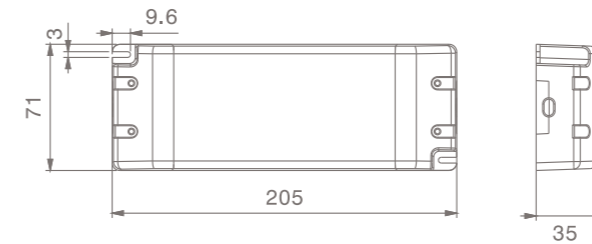

### Constant Voltage

Model	Power (max.)	Input Voltage	Output Voltage	Output Current (max.)	PF	Voltage Tolerance	Efficiency	Dimensions (LxWxH)
YSL150-12	200W	220-240V AC	12V	16.6A	≥ 0.95	± 5%	92%	205x71x35mm
YSL150-24	240W	220-240V AC	24V	10A	≥ 0.95	± 5%	92%	205x71x35mm
YSL150-36	200W	220-240V AC	36V	5.55A	≥ 0.95	± 5%	92%	205x71x35mm
YSL150-48	200W	220-240V AC	48V	4.16A	≥ 0.95	± 5%	92%	205x71x35mm

**YSL320 Series**



**220-240V AC** Input Voltage      **50/60Hz** Input Frequency      **260/320W** Rated Power

- Safety standard: EN61347-1, EN61347-2-13,
- EMI standard: EN55015
- EMS standard: EN61547
- ERP: EU2019/2020
- Protection: Short Circuit/Overload/Over Voltage/Over Temperature
- 100% full load burn in test
- Auto restart after remove of fault conditions
- RoHS Compliance
- IP20



**Dimensions (mm)**

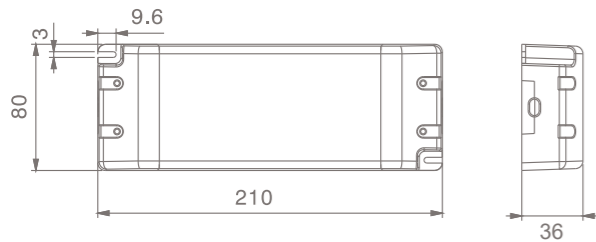

**Constant Voltage**

Model	Power (max.)	Input Voltage	Output Voltage	Output Current (max.)	PF	Voltage Tolerance	Efficiency	Dimensions (LxWxH)
YSL320-12	260W	220-240V AC	12V	21.6A	≥ 0.95	± 5%	92%	210x80x36mm
YSL320-24	320W	220-240V AC	24V	13.3A	≥ 0.95	± 5%	92%	210x80x36mm
YSL320-36	320W	220-240V AC	36V	8.88A	≥ 0.95	± 5%	92%	210x80x36mm
YSL320-48	320W	220-240V AC	48V	6.66A	≥ 0.95	± 5%	92%	210x80x36mm



**IP20 Super Thin**  
LED Power Supply

12W-150W

## YSL12F Series



**220-240V AC**  
Input Voltage

**50/60Hz**  
Input Frequency

**6/12W**  
Rated Power

- Safety standard: EN61347-1, EN61347-2-13,
- EMI standard: EN55015
- EMS standard: EN61547
- ERP: EU2019/2020
- Protection: Short Circuit/Overload/Over Voltage/Over Temperature
- 100% full load burn in test
- Auto restart after remove of fault conditions
- RoHS Compliance
- IP20

### Dimensions (mm)

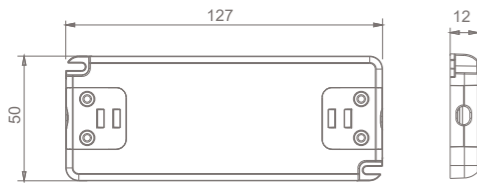

### Constant Voltage

Model	Power (max.)	Input Voltage	Output Voltage	Output Current (max.)	Voltage Tolerance	Ripple (P-P)	Efficiency	Dimensions (LxWxH)
YSL12F-12	12W	220-240V AC	12V	1A	± 5%	< 1%	85%	127x50x12mm
YSL12F-24	12W	220-240V AC	24V	0.5A	± 5%	< 1%	85%	127x50x12mm

### Constant Current

Model	Power (max.)	Input Voltage	Output Current	Output Voltage (max.)	Voltage Tolerance	Efficiency	Dimensions (LxWxH)
YSL12F-350	12W	220-240V AC	350mA	34V	± 5%	85%	127x50x12mm
YSL12F-500	12W	220-240V AC	500mA	24V	± 5%	85%	127x50x12mm
YSL12F-700	12W	220-240V AC	700mA	17V	± 5%	85%	127x50x12mm

## YSL15F Series



**220-240V AC**  
Input Voltage

**50/60Hz**  
Input Frequency

**15W**  
Rated Power

- Safety standard: EN61347-1, EN61347-2-13,
- EMI standard: EN55015
- EMS standard: EN61547
- ERP: EU2019/2020
- Protection: Short Circuit/Overload/Over Voltage/Over Temperature
- 100% full load burn in test
- Auto restart after remove of fault conditions
- RoHS Compliance
- IP20

### Dimensions (mm)

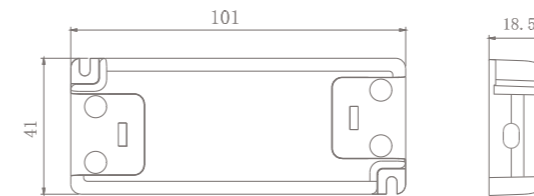

### Constant Voltage

Model	Power (max.)	Input Voltage	Output Voltage	Output Current (max.)	Voltage Tolerance	Ripple (P-P)	Efficiency	Dimensions (LxWxH)
YSL15F-12	15W	220-240V AC	12V	1.25A	± 5%	< 1%	85%	101x41x18.5mm
YSL15F-24	15W	220-240V AC	24V	0.75A	± 5%	< 1%	85%	101x41x18.5mm

YSL20F Series



**220-240V AC** Input Voltage  
**50/60Hz** Input Frequency  
**15/20W** Rated Power

- Safety standard: EN61347-1, EN61347-2-13,
- EMI standard: EN55015
- EMS standard: EN61547
- ERP: EU2019/2020
- Protection: Short Circuit/Overload/Over Voltage/Over Temperature
- 100% full load burn in test
- Auto restart after remove of fault conditions
- RoHS Compliance
- IP20

Dimensions (mm)

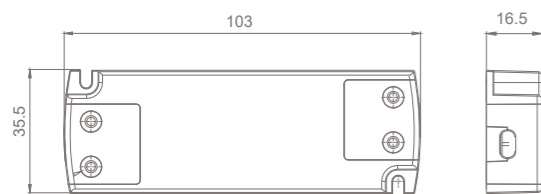

Constant Voltage

Model	Power (max.)	Input Voltage	Output Voltage	Output Current (max.)	Voltage Tolerance	Ripple (P-P)	Efficiency	Dimensions (LxWxH)
YSL20F-12	20W	220-240V AC	12V	1.67A	± 5%	< 1%	88%	103x35.5x16.5mm
YSL20F-24	20W	220-240V AC	24V	0.833A	± 5%	< 1%	88%	103x35.5x16.5mm

Constant Current

Model	Power (max.)	Input Voltage	Output Current	Output Voltage (max.)	Voltage Tolerance	Efficiency	Dimensions (LxWxH)
YSL20F-350	20W	220-240V AC	350mA	57V	± 5%	88%	103x35.5x16.5mm
YSL20F-500	20W	220-240V AC	500mA	40V	± 5%	88%	103x35.5x16.5mm
YSL20F-700	20W	220-240V AC	700mA	28.5V	± 5%	88%	103x35.5x16.5mm

YSL30F Series



**220-240V AC** Input Voltage  
**50/60Hz** Input Frequency  
**30W** Rated Power

- Safety standard: EN61347-1, EN61347-2-13,
- EMI standard: EN55015
- EMS standard: EN61547
- ERP: EU2019/2020
- Protection: Short Circuit/Overload/Over Voltage/Over Temperature
- 100% full load burn in test
- Auto restart after remove of fault conditions
- RoHS Compliance
- IP20

Dimensions (mm)

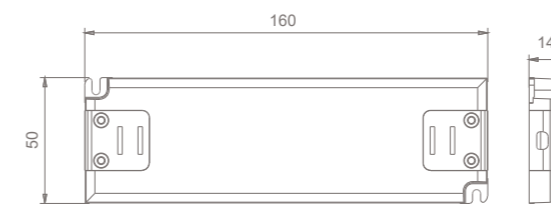

Constant Voltage

Model	Power (max.)	Input Voltage	Output Voltage	Output Current (max.)	PF	Voltage Tolerance	Efficiency	Dimensions (LxWxH)
YSL30F-12	30W	220-240V AC	12V	2.5A	≥ 0.9	± 5%	88%	160x50x14mm
YSL30F-24	30W	220-240V AC	24V	1.25A	≥ 0.9	± 5%	88%	160x50x14mm

## YSL50F Series



**220-240V AC**  
Input Voltage

**50/60Hz**  
Input Frequency

**30/50W**  
Rated Power

- Safety standard: EN61347-1, EN61347-2-13,
- EMI standard: EN55015
- EMS standard: EN61547
- ERP: EU2019/2020
- Protection: Short Circuit/Overload/Over Voltage/Over Temperature
- 100% full load burn in test
- Auto restart after remove of fault conditions
- RoHS Compliance
- IP20

### Dimensions (mm)

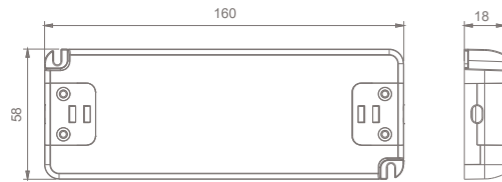

### Constant Voltage

Model	Power (max.)	Input Voltage	Output Voltage	Output Current (max.)	PF	Voltage Tolerance	Efficiency	Dimensions (LxWxH)
YSL50F-12	50W	220-240V AC	12V	4.16A	≥ 0.9	± 5%	88%	160x58x18mm
YSL50F-24	50W	220-240V AC	24V	2.08A	≥ 0.9	± 5%	88%	160x58x18mm
YSL50F-36	50W	220-240V AC	36V	1.38A	≥ 0.9	± 5%	88%	160x58x18mm
YSL50F-48	50W	220-240V AC	48V	1.04A	≥ 0.9	± 5%	88%	160x58x18mm

### Constant Current

Model	Power (max.)	Input Voltage	Output Current	Output Voltage (max.)	PF	Voltage Tolerance	Efficiency	Dimensions (LxWxH)
YSL50F-700	50W	220-240V AC	700mA	71V	≥ 0.9	± 5%	88%	160x58x18mm
YSL50F-1050	50W	220-240V AC	1050mA	48V	≥ 0.9	± 5%	88%	160x58x18mm
YSL50F-1400	50W	220-240V AC	1400mA	35V	≥ 0.9	± 5%	88%	160x58x18mm

## YSL100F Series



**220-240V AC**  
Input Voltage

**50/60Hz**  
Input Frequency

**75/100W**  
Rated Power

- Safety standard: EN61347-1, EN61347-2-13,
- EMI standard: EN55015
- EMS standard: EN61547
- ERP: EU2019/2020
- Protection: Short Circuit/Overload/Over Voltage/Over Temperature
- 100% full load burn in test
- Auto restart after remove of fault conditions
- RoHS Compliance
- IP20

### Dimensions (mm)

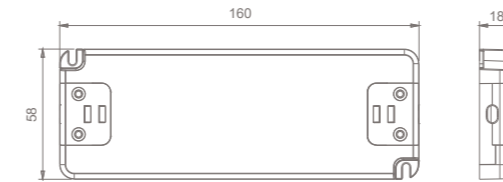

### Constant Voltage

Model	Power (max.)	Input Voltage	Output Voltage	Output Current (max.)	PF	Voltage Tolerance	Efficiency	Dimensions (LxWxH)
YSL100F-12	100W	220-240V AC	12V	8.33A	≥ 0.9	± 5%	92%	160x58x18mm
YSL100F-24	100W	220-240V AC	24V	4.16A	≥ 0.9	± 5%	92%	160x58x18mm
YSL100F-36	100W	220-240V AC	36V	2.77A	≥ 0.9	± 5%	92%	160x58x18mm
YSL100F-48	100W	220-240V AC	48V	2.08A	≥ 0.9	± 5%	92%	160x58x18mm

**YSL150F Series**



**220-240V AC** Input Voltage      **50/60Hz** Input Frequency      **132/150W** Rated Power

- Safety standard: EN61347-1, EN61347-2-13,
- EMI standard: EN55015
- EMS standard: EN61547
- ERP: EU2019/2020
- Protection: Short Circuit/Overload/Over Voltage/Over Temperature
- 100% full load burn in test
- Auto restart after remove of fault conditions
- RoHS Compliance
- IP20

**Dimensions (mm)**

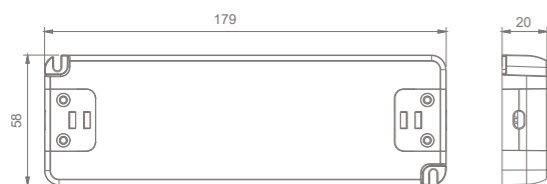

**Constant Voltage**

Model	Power (max.)	Input Voltage	Output Voltage	Output Current (max.)	PF	Voltage Tolerance	Efficiency	Dimensions (LxWxH)
YSL150F-12	132W	220-240V AC	12V	11A	≥ 0.9	± 5%	92%	179x58x20mm
YSL150F-24	150W	220-240V AC	24V	6.25A	≥ 0.9	± 5%	92%	179x58x20mm
YSL150F-36	150W	220-240V AC	36V	4.16A	≥ 0.9	± 5%	92%	179x58x20mm
YSL150F-48	150W	220-240V AC	48V	3.125A	≥ 0.9	± 5%	92%	179x58x20mm



**Cabinet Light**  
LED Power Supply

12W-100W

## YSL12C Series



**220-240V AC**  
Input Voltage

**50/60Hz**  
Input Frequency

**6/12W**  
Rated Power

- Safety standard: EN61347-1, EN61347-2-13,
- EMI standard: EN55015
- EMS standard: EN61547
- ERP: EU2019/2020
- Protection: Short Circuit/Overload/Over Voltage/Over Temperature
- 100% full load burn in test
- Auto restart after remove of fault conditions
- RoHS Compliance
- IP20

### Dimensions (mm)

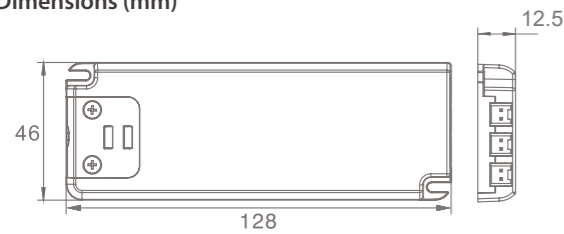

CE SELV RoHS UK CR

### Constant Voltage

Model	Power (max.)	Input Voltage	Output Voltage	Output Current (max.)	Voltage Tolerance	Ripple (P-P)	Efficiency	Dimensions (LxWxH)
YSL12C-12	12W	220-240V AC	12V	1A	± 5%	< 1%	85%	128x46x12.5mm
YSL12C-24	12W	220-240V AC	24V	0.5A	± 5%	< 1%	85%	128x46x12.5mm

## YSL20C Series



**220-240V AC**  
Input Voltage

**50/60Hz**  
Input Frequency

**15/20W**  
Rated Power

- Safety standard: EN61347-1, EN61347-2-13,
- EMI standard: EN55015
- EMS standard: EN61547
- ERP: EU2019/2020
- Protection: Short Circuit/Overload/Over Voltage/Over Temperature
- 100% full load burn in test
- Auto restart after remove of fault conditions
- RoHS Compliance
- IP20

### Dimensions (mm)

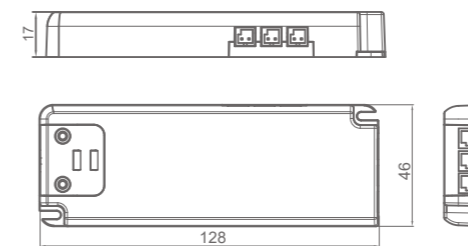

CE SELV RoHS UK CR

### Constant Voltage

Model	Power (max.)	Input Voltage	Output Voltage	Output Current (max.)	Voltage Tolerance	Ripple (P-P)	Efficiency	Dimensions (LxWxH)
YSL20C-12	20W	220-240V AC	12V	1.67A	± 5%	< 1%	88%	128x46x17mm
YSL20C-24	20W	220-240V AC	24V	0.833A	± 5%	< 1%	88%	128x46x17mm



## YSL60C Series



**220-240V AC**  
Input Voltage

**50/60Hz**  
Input Frequency

**30/60W**  
Rated Power

- Safety standard: EN61347-1, EN61347-2-13,
- EMI standard: EN55015
- EMS standard: EN61547
- ERP: EU2019/2020
- Protection: Short Circuit/Overload/Over Voltage/Over Temperature
- 100% full load burn in test
- Auto restart after remove of fault conditions
- RoHS Compliance
- IP20

### Dimensions (mm)

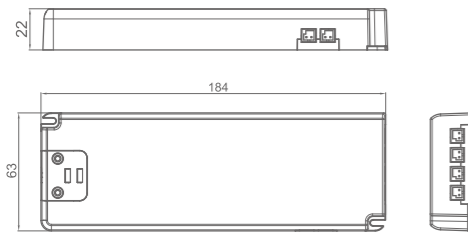

CE SELV RoHS UK CR

### Constant Voltage

Model	Power (max.)	Input Voltage	Output Voltage	Output Current (max.)	PF	Voltage Tolerance	Efficiency	Dimensions (LxWxH)
YSL60C-12	60W	220-240V AC	12V	5A	≥0.9	±5%	92%	184x63x22mm
YSL60C-24	60W	220-240V AC	24V	2.5A	≥0.9	±5%	92%	184x63x22mm
YSL60C-36	60W	220-240V AC	36V	1.67A	≥0.9	±5%	92%	184x63x22mm
YSL60C-48	60W	220-240V AC	48V	1.25A	≥0.9	±5%	92%	184x63x22mm

## YSL100C Series



**220-240V AC**  
Input Voltage

**50/60Hz**  
Input Frequency

**75/100W**  
Rated Power

- Safety standard: EN61347-1, EN61347-2-13,
- EMI standard: EN55015
- EMS standard: EN61547
- ERP: EU2019/2020
- Protection: Short Circuit/Overload/Over Voltage/Over Temperature
- 100% full load burn in test
- Auto restart after remove of fault conditions
- RoHS Compliance
- IP20

### Dimensions (mm)

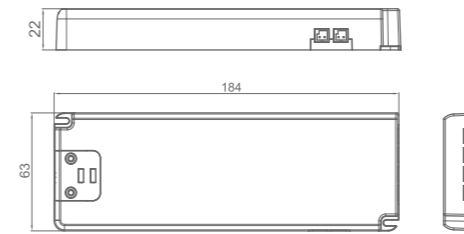

CE SELV RoHS UK CR

### Constant Voltage

Model	Power (max.)	Input Voltage	Output Voltage	Output Current (max.)	PF	Voltage Tolerance	Efficiency	Dimensions (LxWxH)
YSL100C-12	100W	220-240V AC	12V	8.33A	≥0.9	±5%	92%	184x63x22mm
YSL100C-24	100W	220-240V AC	24V	4.16A	≥0.9	±5%	92%	184x63x22mm
YSL100C-36	100W	220-240V AC	36V	2.77A	≥0.9	±5%	92%	184x63x22mm
YSL100C-48	100W	220-240V AC	48V	2.08A	≥0.9	±5%	92%	184x63x22mm

## YLC20S Series

Smart Control



**220-240V AC**  
Input Voltage

**50/60Hz**  
Input Frequency

**15/20W**  
Rated Power

**Product features:**

- Input: 220-240VAC 50/60Hz
- Output: 4 output
- Constant Voltage
- C8 plug input
- Built-In connectors for led strip
- Built in connectors for on/off sensors
- Optional a module interface

**Standards:**

- IEC61347 IEC55015 IEC61000 IEC61547



**Dimensions (mm)**

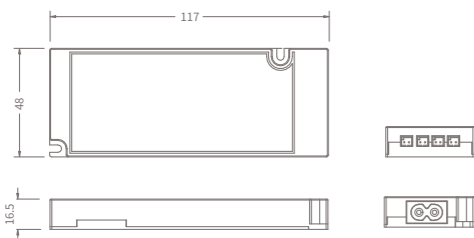

**Constant Voltage**

Model	Power (max.)	Input Voltage	Output Voltage	Output Current (max.)	PF	Voltage Tolerance	Efficiency	Dimensions (LxWxH)
YSL20S-12	20W	220-240V AC	12V	1.66A	≥0.9	±5%	83%	117x48x16.5mm
YSL20S-24	20W	220-240V AC	24V	0.83A	≥0.9	±5%	83%	117x48x16.5mm

## YLC40S Series

Smart Control



**220-240V AC**  
Input Voltage

**50/60Hz**  
Input Frequency

**40W**  
Rated Power

**Product features:**

- Input: 220-240VAC 50/60Hz
- Output: 6 output
- Constant Voltage
- C8 plug input
- Built-In connectors for led strip
- Built in connectors for on/off sensors
- Optional a module interface

**Standards:**

- IEC61347 IEC55015 IEC61000 IEC61547



**Dimensions (mm)**

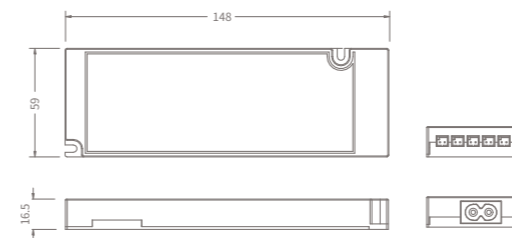

**Constant Voltage**

Model	Power (max.)	Input Voltage	Output Voltage	Output Current (max.)	PF	Voltage Tolerance	Efficiency	Dimensions (LxWxH)
YSL40S-12	40W	220-240V AC	12V	3.33A	≥0.9	±5%	86%	148x59x16.5mm
YSL40S-24	40W	220-240V AC	24V	1.66A	≥0.9	±5%	86%	148x59x16.5mm

## YLC60S Series

Smart Control



**220-240V AC**  
Input Voltage

**50/60Hz**  
Input Frequency

**60W**  
Rated Power

**Product features:**

- Input: 220-240VAC 50/60Hz
- Output: 4 output
- Constant Voltage
- C8 plug input
- Built-in connectors for led strip
- Built in connectors for on/off sensors
- Optional a module interface

**Standards:**

- IEC61347 IEC55015 IEC61000 IEC61547



**Dimensions (mm)**

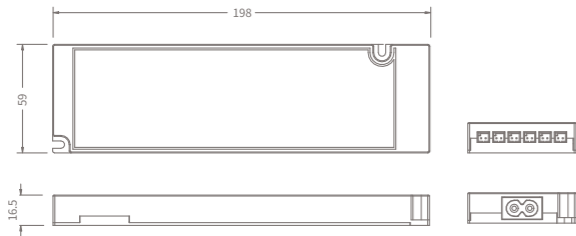

**Constant Voltage**

Model	Power (max.)	Input Voltage	Output Voltage	Output Current (max.)	PF	Voltage Tolerance	Efficiency	Dimensions (LxWxH)
YSL60S-12	60W	220-240V AC	12V	5AA	≥0.9	±5%	88.5%	198x59x16.5mm
YSL60S-24	60W	220-240V AC	24V	2.5A	≥0.9	±5%	88.5%	198x59x16.5mm

## YLC100S Series

Smart Control



**220-240V AC**  
Input Voltage

**50/60Hz**  
Input Frequency

**100W**  
Rated Power

**Product features:**

- Input: 220-240VAC 50/60Hz
- Output: 6 output
- Constant Voltage
- C8 plug input
- Built-in connectors for led strip
- Built in connectors for on/off sensors
- Optional a module interface

**Standards:**

- IEC61347 IEC55015 IEC61000 IEC61547



**Dimensions (mm)**

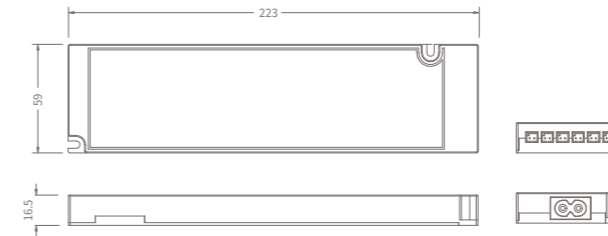

**Constant Voltage**

Model	Power (max.)	Input Voltage	Output Voltage	Output Current (max.)	PF	Voltage Tolerance	Efficiency	Dimensions (LxWxH)
YSL100S-12	100W	220-240V AC	12V	8.33A	≥0.9	±5%	88.5%	223x59x16.5mm
YSL100S-24	100W	220-240V AC	24V	4.16A	≥0.9	±5%	88.5%	223x59x16.5mm

## YSL30S-S Series

Smart Control  
Single Colour



**220-240V AC**  
Input Voltage

**50/60Hz**  
Input Frequency

**30W**  
Rated Power

**Product features:**

- Input: 220-240VAC 50/60Hz
- C8 plug input
- Output: 5 Output 2 Pin
- Constant Voltage
- Wifi/Remote Control / Single colour
- Short Circuit Protection, Over Current Protection, Over Voltage Protection

**Standards:**

- IEC61347 IEC55015 IEC61000 IEC61547



**Dimensions (mm)**

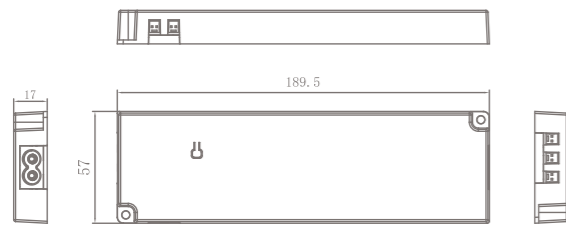

**Constant Voltage**

Model	Power (max.)	Input Voltage	Output Voltage	Output Current (max.)	PF	Voltage Tolerance	Efficiency	Dimensions (LxWxH)
YSL30S-S-12	30W	220-240V AC	12V	2.5A	≥0.9	±5%	92%	189.5x57x17mm
YSL30S-S-24	30W	220-240V AC	24V	1.25A	≥0.9	±5%	92%	189.5x57x17mm

## YSL30S-R Series

Smart Control  
CCT / RGB



**220-240V AC**  
Input Voltage

**50/60Hz**  
Input Frequency

**30W**  
Rated Power

**Product features:**

- Input: 220-240VAC 50/60Hz
- C8 plug input
- Output: 4 Output 6 Pin
- Constant Voltage
- Wifi/Remote Control / Single colour
- Short Circuit Protection, Over Current Protection, Over Voltage Protection

**Standards:**

- IEC61347 IEC55015 IEC61000 IEC61547



**Dimensions (mm)**

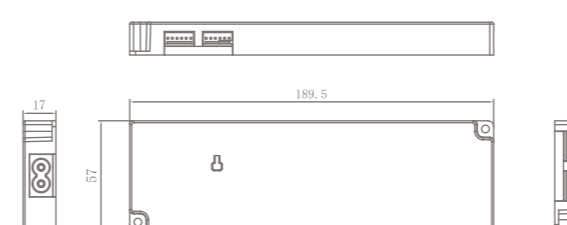

**Constant Voltage**

Model	Power (max.)	Input Voltage	Output Voltage	Output Current (max.)	PF	Voltage Tolerance	Efficiency	Dimensions (LxWxH)
YSL30S-R-12	30W	220-240V AC	12V	2.5A	≥0.9	±5%	92%	189.5x57x17mm
YSL30S-R-24	30W	220-240V AC	24V	1.25A	≥0.9	±5%	92%	189.5x57x17mm

**YSL15T Series**

**220-240V AC**  
Input Voltage

**50/60Hz**  
Input Frequency

**15/18W**  
Rated Power



- Safety standard: EN61347-1, EN61347-2-13,
- EMI standard: EN55015
- EMS standard: EN61547
- ERP: EU2019/2020
- Protection: Short Circuit/Overload/Over Voltage/Over Temperature
- 100% full load burn in test
- Auto restart after remove of fault conditions
- RoHS Compliance
- IP20

**Dimensions (mm)**

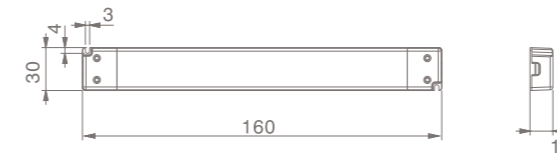

**LineType**  
LED Power Supply

15W-200W

**Constant Voltage**

Model	Power (max.)	Input Voltage	Output Voltage	Output Current (max.)	Voltage Tolerance	Ripple (P-P)	Efficiency	Dimensions (LxWxH)
YSL15T-12	15W	220-240V AC	12V	1.25A	±5%	<1%	88%	160x30x16mm
YSL15T-24	18W	220-240V AC	24V	0.75A	±5%	<1%	88%	160x30x16mm

**Constant Current**

Model	Power (max.)	Input Voltage	Output Current	Output Voltage (max.)	Voltage Tolerance	Efficiency	Dimensions (LxWxH)
YSL15T-350	15W	220-240V AC	350mA	42V	±5%	88%	160x30x16mm
YSL15T-500	15W	220-240V AC	500mA	30V	±5%	88%	160x30x16mm
YSL15T-700	15W	220-240V AC	700mA	21V	±5%	88%	160x30x16mm

## YSL30T Series



**220-240V AC**  
Input Voltage

**50/60Hz**  
Input Frequency

**30/45W**  
Rated Power

- Safety standard: EN61347-1, EN61347-2-13,
- EMI standard: EN55015
- EMS standard: EN61547
- ERP: EU2019/2020
- Protection: Short Circuit/Overload/Over Voltage/Over Temperature
- 100% full load burn in test
- Auto restart after remove of fault conditions
- RoHS Compliance
- IP20

### Dimensions (mm)



### Constant Voltage

Model	Power (max.)	Input Voltage	Output Voltage	Output Current (max.)	PF	Voltage Tolerance	Efficiency	Dimensions (LxWxH)
YSL30T-12	45W	220-240V AC	12V	3.75A	≥0.9	±5%	86%	251x30x17mm
YSL30T-24	45W	220-240V AC	24V	1.875A	≥0.9	±5%	86%	251x30x17mm

### Constant Current

Model	Power (max.)	Input Voltage	Output Current	Output Voltage (max.)	PF	Voltage Tolerance	Efficiency	Dimensions (LxWxH)
YSL30T-500	30W	220-240V AC	500mA	60V	≥0.9	±5%	88%	251x30x17mm
YSL30T-700	30W	220-240V AC	700mA	42.8V	≥0.9	±5%	88%	251x30x17mm

## YSL75T Series



**220-240V AC**  
Input Voltage

**50/60Hz**  
Input Frequency

**60/75W**  
Rated Power

- Safety standard: EN61347-1, EN61347-2-13,
- EMI standard: EN55015
- EMS standard: EN61547
- ERP: EU2019/2020
- Protection: Short Circuit/Overload/Over Voltage/Over Temperature
- 100% full load burn in test
- Auto restart after remove of fault conditions
- RoHS Compliance
- IP20

### Dimensions (mm)

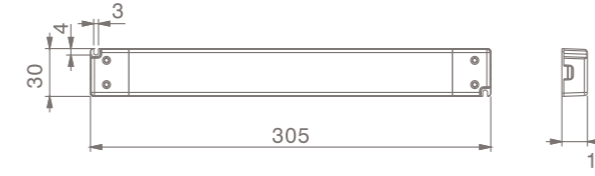

### Constant Voltage

Model	Power (max.)	Input Voltage	Output Voltage	Output Current (max.)	PF	Voltage Tolerance	Efficiency	Dimensions (LxWxH)
YSL75T-12	75W	220-240V AC	12V	6.25A	≥0.95	±5%	89%	305x30x17mm
YSL75T-24	75W	220-240V AC	24V	3.125A	≥0.95	±5%	89%	305x30x17mm
YSL75T-36	75W	220-240V AC	36V	2.08A	≥0.95	±5%	89%	305x30x17mm
YSL75T-48	75W	220-240V AC	48V	1.56A	≥0.95	±5%	89%	305x30x17mm

## YSL100T Series



**220-240V AC**  
Input Voltage

**50/60Hz**  
Input Frequency

**100/150W**  
Rated Power

- Safety standard: EN61347-1, EN61347-2-13,
- EMI standard: EN55015
- EMS standard: EN61547
- ERP: EU2019/2020
- Protection: Short Circuit/Overload/Over Voltage/Over Temperature
- 100% full load burn in test
- Auto restart after remove of fault conditions
- RoHS Compliance
- IP20

### Dimensions (mm)



### Constant Voltage

Model	Power (max.)	Input Voltage	Output Voltage	Output Current (max.)	PF	Voltage Tolerance	Efficiency	Dimensions (LxWxH)
YSL100T-12	100W	220-240V AC	12V	8.33A	≥ 0.95	± 5%	92%	320x30x19mm
YSL100T-24	150W	220-240V AC	24V	6.25A	≥ 0.95	± 5%	92%	320x30x19mm
YSL100T-36	100W	220-240V AC	36V	2.77V	≥ 0.95	± 5%	92%	320x30x19mm
YSL100T-48	100W	220-240V AC	48V	2.08V	≥ 0.95	± 5%	92%	320x30x19mm

## YSL150T Series



**220-240V AC**  
Input Voltage

**50/60Hz**  
Input Frequency

**150/200W**  
Rated Power

- Safety standard: EN61347-1, EN61347-2-13,
- EMI standard: EN55015
- EMS standard: EN61547
- ERP: EU2019/2020
- Protection: Short Circuit/Overload/Over Voltage/Over Temperature
- 100% full load burn in test
- Auto restart after remove of fault conditions
- RoHS Compliance
- IP20

### Dimensions (mm)

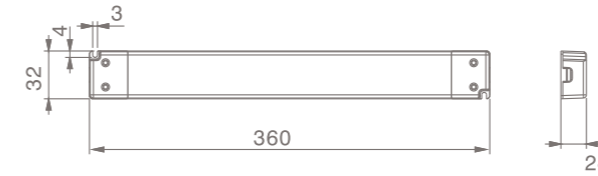

### Constant Voltage

Model	Power (max.)	Input Voltage	Output Voltage	Output Current (max.)	PF	Voltage Tolerance	Efficiency	Dimensions (LxWxH)
YSL150T-12	200W	220-240V AC	12V	16.6A	≥ 0.95	± 5%	92%	360x32x24mm
YSL150T-24	200W	220-240V AC	24V	8.3A	≥ 0.95	± 5%	92%	360x32x24mm
YSL150T-36	200W	220-240V AC	36V	5.55A	≥ 0.95	± 5%	92%	360x32x24mm
YSL150T-48	200W	220-240V AC	48V	4.16A	≥ 0.95	± 5%	92%	360x32x24mm

**YSL12M Series**

**220-240V AC**  
Input Voltage

**50/60Hz**  
Input Frequency

**6/12W**  
Rated Power



- Safety standard: EN61347-1, EN61347-2-13,
- EMI standard: EN55015
- EMS standard: EN61547
- ERP: EU2019/2020
- Protection: Short Circuit/Overload/Over Voltage/Over Temperature
- 100% full load burn in test
- Auto restart after remove of fault conditions
- RoHS Compliance
- IP44

**Dimensions (mm)**

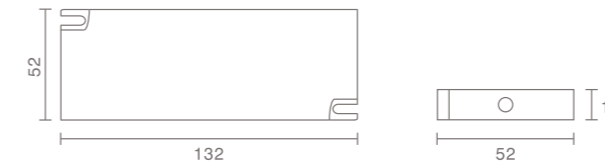

**Constant Voltage**

Model	Power (max.)	Input Voltage	Output Voltage	Output Current (max.)	Voltage Tolerance	Ripple (P-P)	Efficiency	Dimensions (LxWxH)
YSL12M-12	12W	220-240V AC	12V	1V	± 5%	< 1%	85%	132x52x12mm
YSL12M-24	12W	220-240V AC	24V	0.5A	± 5%	< 1%	85%	132x52x12mm

**IP44 Super Thin**  
LED Power Supply

12W-150W



## YSL20M Series



**220-240V AC** Input Voltage      **50/60Hz** Input Frequency      **15/20W** Rated Power

- Safety standard: EN61347-1, EN61347-2-13,
- EMI standard: EN55015
- EMS standard: EN61547
- ERP: EU2019/2020
- Protection: Short Circuit/Overload/Over Voltage/Over Temperature
- 100% full load burn in test
- Auto restart after remove of fault conditions
- RoHS Compliance
- IP44

### Dimensions (mm)

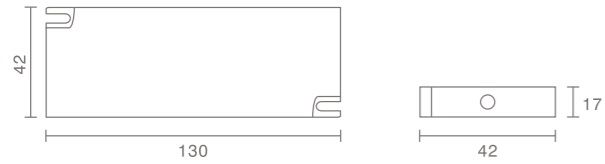

### Constant Voltage

Model	Power (max.)	Input Voltage	Output Voltage	Output Current (max.)	Voltage Tolerance	Efficiency	Dimensions (LxWxH)
YSL20M-12	20W	220-240V AC	12V	1.67V	±5%	86%	130x42x17mm
YSL20M-24	20W	220-240V AC	24V	0.83V	±5%	86%	130x42x17mm

## YSL50M Series



**220-240V AC** Input Voltage      **50/60Hz** Input Frequency      **30/50W** Rated Power

- Safety standard: EN61347-1, EN61347-2-13,
- EMI standard: EN55015
- EMS standard: EN61547
- ERP: EU2019/2020
- Protection: Short Circuit/Overload/Over Voltage/Over Temperature
- 100% full load burn in test
- Auto restart after remove of fault conditions
- RoHS Compliance
- IP44

### Dimensions (mm)

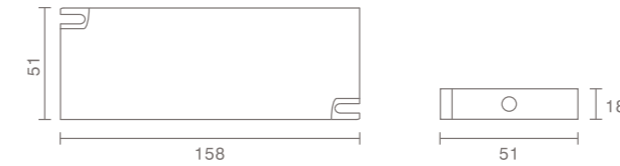

### Constant Voltage

Model	Power (max.)	Input Voltage	Output Voltage	Output Current (max.)	PF	Voltage Tolerance	Efficiency	Dimensions (LxWxH)
YSL50M-12	50W	220-240V AC	12V	4.16V	≥0.9	±5%	88%	158x51x18mm
YSL50M-24	50W	220-240V AC	24V	2.08V	≥0.9	±5%	88%	158x51x18mm

## YSL100M Series

**220-240V AC** Input Voltage  
**50/60Hz** Input Frequency  
**75/100W** Rated Power

- Safety standard: EN61347-1, EN61347-2-13,
- EMI standard: EN55015
- EMS standard: EN61547
- ERP: EU2019/2020
- Protection: Short Circuit/Overload/Over Voltage/Over Temperature
- 100% full load burn in test
- Auto restart after remove of fault conditions
- RoHS Compliance
- IP44

### Dimensions (mm)

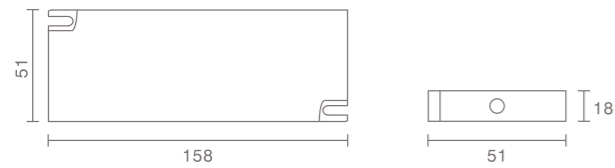

### Constant Voltage

Model	Power (max.)	Input Voltage	Output Voltage	Output Current (max.)	PF	Voltage Tolerance	Efficiency	Dimensions (LxWxH)
YSL100M-12	100W	220-240V AC	12V	8.3A	≥ 0.9	± 5%	92%	158x51x18mm
YSL100M-24	100W	220-240V AC	24V	4.16A	≥ 0.9	± 5%	92%	158x51x18mm
YSL100M-36	100W	220-240V AC	36V	2.77A	≥ 0.9	± 5%	92%	158x51x18mm
YSL100M-48	100W	220-240V AC	48V	2.08A	≥ 0.9	± 5%	92%	158x51x18mm

## YSL150M Series

**220-240V AC** Input Voltage  
**50/60Hz** Input Frequency  
**132/150W** Rated Power

- Safety standard: EN61347-1, EN61347-2-13,
- EMI standard: EN55015
- EMS standard: EN61547
- ERP: EU2019/2020
- Protection: Short Circuit/Overload/Over Voltage/Over Temperature
- 100% full load burn in test
- Auto restart after remove of fault conditions
- RoHS Compliance
- IP44

### Dimensions (mm)

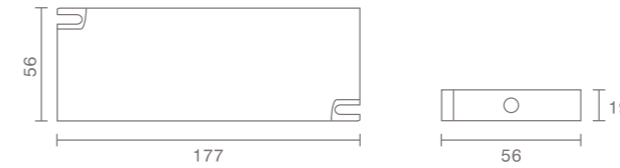

### Constant Voltage

Model	Power (max.)	Input Voltage	Output Voltage	Output Current (max.)	PF	Voltage Tolerance	Efficiency	Dimensions (LxWxH)
YSL150M-12	132W	220-240V AC	12V	11A	≥ 0.95	± 5%	92%	177x56x19mm
YSL150M-24	150W	220-240V AC	24V	6.25A	≥ 0.95	± 5%	92%	177x56x19mm
YSL150M-36	150W	220-240V AC	36V	4.16A	≥ 0.95	± 5%	92%	177x56x19mm
YSL150M-48	150W	220-240V AC	48V	3.125A	≥ 0.95	± 5%	92%	177x56x19mm

# Waterproof LED Power Supply

6W-200W

## Waterproof LED Power Supply

### YCL12 Series

**220-240V AC**  
Input Voltage

**50/60Hz**  
Input Frequency

**12W**  
Rated Power

- Safety standard: EN61347-1, EN61347-2-13,
- EMI standard: EN55015
- EMS standard: EN61547
- ERP: EU2019/2020
- Protection: Short Circuit/Overload/Over Voltage/Over Temperature
- 100% full load burn in test
- Auto restart after remove of fault conditions
- RoHS Compliance
- IP67



#### Dimensions (mm)

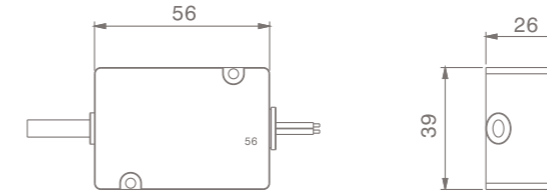

### YCL12R Series

**220-240V AC**  
Input Voltage

**50/60Hz**  
Input Frequency

**12W**  
Rated Power

- Safety standard: EN61347-1, EN61347-2-13,
- EMI standard: EN55015
- EMS standard: EN61547
- ERP: EU2019/2020
- Protection: Short Circuit/Overload/Over Voltage/Over Temperature
- 100% full load burn in test
- Auto restart after remove of fault conditions
- RoHS Compliance
- IP67



#### Dimensions (mm)

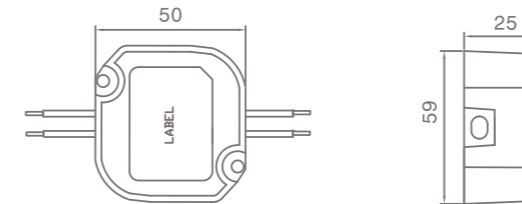

#### Constant Voltage

Model	Power (max.)	Input Voltage	Output Voltage (max.)	Voltage Tolerance	Ripple (p-p)	Efficiency	Dimensions (LxWxH)
YCL12-V	12W	220-240V AC	12V/24V	± 5%	< 1%	82%	56x39x26mm
YCL12R-V	12W	220-240V AC	12V/24V	± 5%	< 1%	82%	50x50x25mm

#### Constant Current

Model	Power (max.)	Input Voltage	Output Current (max.)	Output Voltage (max.)	Voltage Tolerance	Efficiency	Dimensions (LxWxH)
YCL12-350	12W	220-240V AC	350mA	34V	± 5%	82%	56x39x26mm
YCL12R-500	12W	220-240V AC	500mA	24V	± 5%	82%	50x50x25mm



**Dimensions (mm)**

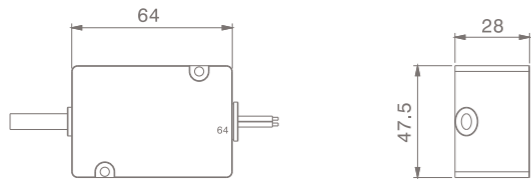

**YCL20 Series**

**220-240V AC** Input Voltage      **50/60Hz** Input Frequency      **20W** Rated Power

- Safety standard: EN61347-1,EN61347-2-13,
- EMI standard: EN55015
- EMS standard: EN61547
- ERP: EU2019/2020
- Protection:Short Circuit/Overload/Over Voltage/Over Temperature
- 100% full load burn in test
- Auto restart after remove of fault conditions
- RoHS Compliance
- IP67



**YCL20R Series**

**220-240V AC** Input Voltage      **50/60Hz** Input Frequency      **20W** Rated Power

- Safety standard: EN61347-1,EN61347-2-13,
- EMI standard: EN55015
- EMS standard: EN61547
- ERP: EU2019/2020
- Protection:Short Circuit/Overload/Over Voltage/Over Temperature
- 100% full load burn in test
- Auto restart after remove of fault conditions
- RoHS Compliance
- IP67



**Dimensions (mm)**

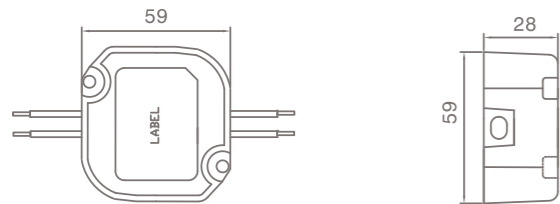

**Constant Voltage**

Model	Power (max.)	Input Voltage	Output Voltage (max.)	Voltage Tolerance	Current Pipple & Noise (p-p)	Efficiency	Dimensions (LxWxH)
YCL20-V	20W	220-240V AC	12V/24V	± 5%	< 1%	86%	64x47.5x28mm
YCL20R-V	20W	220-240V AC	12V/24V	± 5%	< 1%	86%	59x59x28mm

**YCL6 Series**

**220-240V AC** Input Voltage      **50/60Hz** Input Frequency      **6W** Rated Power

- Safety standard: EN61347-1,EN61347-2-13,
- EMI standard: EN55015
- EMS standard: EN61547
- ERP: EU2019/2020
- Protection:Short Circuit/Overload/Over Voltage/Over Temperature
- 100% full load burn in test
- Auto restart after remove of fault conditions
- RoHS Compliance
- IP66



**Dimensions (mm)**

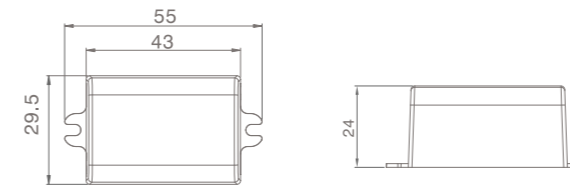

**Constant Voltage**

Model	Power (max.)	Input Voltage	Output Voltage	Output Current (max.)	Voltage Tolerance	Riple (P-P)	Efficiency	Dimensions (LxWxH)
YCL6-12	6W	220-240V AC	12V	0.5A	± 5%	< 1%	79%	55x29.5x24mm
YCL6-24	6W	220-240V AC	24V	0.25A	± 5%	< 1%	79%	55x29.5x24mm

**Constant Current**

Model	Power (max.)	Input Voltage	Output Current	Output Voltage (max.)	Voltage Tolerance	Efficiency	Dimensions (LxWxH)
YCL6-350	6W	220-240V AC	350mA	17V	± 5%	85%	55x29.5x24mm
YCL6-500	6W	220-240V AC	500mA	12V	± 5%	85%	55x29.5x24mm
YCL6-700	6W	220-240V AC	700mA	8.5V	± 5%	85%	55x29.5x24mm

## YCL15 Series



**220-240V AC** Input Voltage      **50/60Hz** Input Frequency      **18W** Rated Power

- Safety standard: EN61347-1,EN61347-2-13,
- EMI standard: EN55015
- EMS standard: EN61547
- ERP: EU2019/2020
- Protection:Short Circuit/Overload/Over Voltage/Over Temperature
- 100% full load burn in test
- Auto restart after remove of fault conditions
- RoHS Compliance
- IP66

### Dimensions (mm)

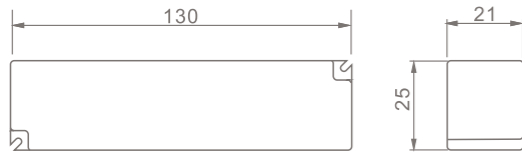

CE SELV RoHS UK CA

### Constant Voltage

Model	Power (max.)	Input Voltage	Output Voltage	Output Current (max.)	Voltage Tolerance	Efficiency	Dimensions (LxWxH)
YCL15-12	18W	220-240V AC	12V	1.5A	± 5%	86%	130x25x21mm
YCL15-24	18W	220-240V AC	24V	0.75A	± 5%	86%	130x25x21mm

### Constant Current

Model	Power (max.)	Input Voltage	Output Current	Output Voltage (max.)	Voltage Tolerance	Efficiency	Dimensions (LxWxH)
YCL15-350	18W	220-240V AC	350mA	51V	± 5%	88%	130x25x21mm
YCL15-500	18W	220-240V AC	500mA	36V	± 5%	88%	130x25x21mm
YCL15-700	18W	220-240V AC	700mA	25.7V	± 5%	88%	130x25x21mm

## YCL24 Series



**220-240V AC** Input Voltage      **50/60Hz** Input Frequency      **24W** Rated Power

- Safety standard: EN61347-1,EN61347-2-13,
- EMI standard: EN55015
- EMS standard: EN61547
- ERP: EU2019/2020
- Protection:Short Circuit/Overload/Over Voltage/Over Temperature
- 100% full load burn in test
- Auto restart after remove of fault conditions
- RoHS Compliance
- IP67

### Dimensions (mm)

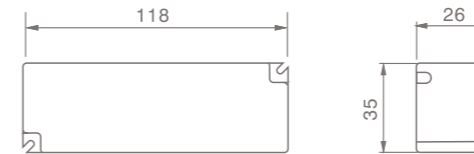

DEKRA CE SELV RoHS UK CA

### Constant Voltage

Model	Power (max.)	Input Voltage	Output Voltage	Output Current (max.)	Voltage Tolerance	Ripple (P-P)	Efficiency	Dimensions (LxWxH)
YCL24-12	24W	220-240V AC	12V	2A	± 5%	< 1%	86%	118x35x26mm
YCL24-24	24W	220-240V AC	24V	1A	± 5%	< 1%	86%	118x35x26mm

### Constant Current

Model	Power (max.)	Input Voltage	Output Current	Output Voltage (max.)	Voltage Tolerance	Efficiency	Dimensions (LxWxH)
YCL24-350	24W	220-240V AC	350mA	68V	± 5%	85%	118x35x26mm
YCL24-500	24W	220-240V AC	500mA	48V	± 5%	85%	118x35x26mm
YCL24-700	24W	220-240V AC	700mA	34V	± 5%	85%	118x35x26mm

## YCL40 Series



**220-240V AC** Input Voltage      **50/60Hz** Input Frequency      **40W** Rated Power

- Safety standard: EN61347-1, EN61347-2-13,
- EMI standard: EN55015
- EMS standard: EN61547
- ERP: EU2019/2020
- Protection: Short Circuit/Overload/Over Voltage/Over Temperature
- 100% full load burn in test
- Auto restart after remove of fault conditions
- RoHS Compliance
- IP67

### Dimensions (mm)



### Constant Voltage

Model	Power (max.)	Input Voltage	Output Voltage	Output Current (max.)	PF	Voltage Tolerance	Efficiency	Dimensions (LxWxH)
YCL40-12	40W	220-240V AC	12V	3.33A	≥0.9	±5%	86%	148x40x30mm
YCL40-24	40W	220-240V AC	24V	1.66A	≥0.9	±5%	86%	148x40x30mm

### Constant Current

Model	Power (max.)	Input Voltage	Output Current	Output Voltage (max.)	PF	Voltage Tolerance	Efficiency	Dimensions (LxWxH)
YCL40-500	40W	220-240V AC	500mA	80V	≥0.9	±5%	88%	148x40x30mm
YCL40-700	40W	220-240V AC	700mA	57V	≥0.9	±5%	88%	148x40x30mm
YCL40-1050	40W	220-240V AC	1050mA	38V	≥0.9	±5%	88%	148x40x30mm

## YCL60 Series



**220-240V AC** Input Voltage      **50/60Hz** Input Frequency      **60W** Rated Power

- Safety standard: EN61347-1, EN61347-2-13,
- EMI standard: EN55015
- EMS standard: EN61547
- ERP: EU2019/2020
- Protection: Short Circuit/Overload/Over Voltage/Over Temperature
- 100% full load burn in test
- Auto restart after remove of fault conditions
- RoHS Compliance
- IP67

### Dimensions (mm)



### Constant Voltage

Model	Power (max.)	Input Voltage	Output Voltage	Output Current (max.)	PF	Voltage Tolerance	Efficiency	Dimensions (LxWxH)
YCL60-12	60W	220-240V AC	12V	5A	≥0.9	±5%	90%	163x43x33mm
YCL60-24	60W	220-240V AC	24V	2.5A	≥0.9	±5%	90%	163x43x33mm
YCL60-36	60W	220-240V AC	36V	1.66A	≥0.9	±5%	90%	163x43x33mm
YCL60-48	60W	220-240V AC	48V	1.25A	≥0.9	±5%	90%	163x43x33mm

### Constant Current

Model	Power (max.)	Input Voltage	Output Current	Output Voltage (max.)	PF	Voltage Tolerance	Efficiency	Dimensions (LxWxH)
YCL60-700	60W	220-240V AC	700mA	85V	≥0.9	±5%	90%	163x43x33mm
YCL60-1050	60W	220-240V AC	1050mA	57V	≥0.9	±5%	90%	163x43x33mm
YCL60-1400	60W	220-240V AC	1400mA	42V	≥0.9	±5%	90%	163x43x33mm

## YCL100 Series



**220-240V AC** Input Voltage      **50/60Hz** Input Frequency      **100W** Rated Power

- Safety standard: EN61347-1, EN61347-2-13,
- EMI standard: EN55015
- EMS standard: EN61547
- ERP: EU2019/2020
- Protection: Short Circuit/Overload/Over Voltage/Over Temperature
- 100% full load burn in test
- Auto restart after remove of fault conditions
- RoHS Compliance
- IP67

### Dimensions (mm)



DEKRA CE SELV RoHS UK CA

### Constant Voltage

Model	Power (max.)	Input Voltage	Output Voltage	Output Current (max.)	PF	Voltage Tolerance	Efficiency	Dimensions (LxWxH)
YCL100-12	100W	220-240V AC	12V	8.33A	≥0.9	±5%	90%	190x52x37mm
YCL100-24	100W	220-240V AC	24V	4.16A	≥0.9	±5%	92%	190x52x37mm
YCL100-36	100W	220-240V AC	36V	2.77A	≥0.9	±5%	92%	190x52x37mm
YCL100-48	100W	220-240V AC	48V	2.08A	≥0.9	±5%	92%	190x52x37mm

### Constant Current

Model	Power (max.)	Input Voltage	Output Current	Output Voltage (max.)	PF	Voltage Tolerance	Efficiency	Dimensions (LxWxH)
YCL100-700	100W	220-240V AC	700mA	142V	≥0.9	±5%	92%	190x52x37mm
YCL100-1050	100W	220-240V AC	1050mA	95V	≥0.9	±5%	92%	190x52x37mm
YCL100-1400	100W	220-240V AC	1400mA	71V	≥0.9	±5%	92%	190x52x37mm
YCL100-2100	100W	220-240V AC	2100mA	47V	≥0.9	±5%	92%	190x52x37mm

## YCL150 Series



**220-240V AC** Input Voltage      **50/60Hz** Input Frequency      **150/200W** Rated Power

- Safety standard: EN61347-1, EN61347-2-13,
- EMI standard: EN55015
- EMS standard: EN61547
- ERP: EU2019/2020
- Protection: Short Circuit/Overload/Over Voltage/Over Temperature
- 100% full load burn in test
- Auto restart after remove of fault conditions
- RoHS Compliance
- IP67

### Dimensions (mm)



DEKRA CE SELV RoHS UK CA

### Constant Voltage

Model	Power (max.)	Input Voltage	Output Voltage	Output Current (max.)	PF	Voltage Tolerance	Efficiency	Dimensions (LxWxH)
YCL150-12	200W	220-240V AC	12V	16.6A	≥0.9	±5%	92%	191x68x37mm
YCL150-24	200W	220-240V AC	24V	8.3A	≥0.9	±5%	92%	191x68x37mm
YCL150-36	200W	220-240V AC	36V	5.5A	≥0.9	±5%	92%	191x68x37mm
YCL150-48	200W	220-240V AC	48V	4.16A	≥0.9	±5%	92%	191x68x37mm

### Constant Current

Model	Power (max.)	Input Voltage	Output Current	Output Voltage (max.)	PF	Voltage Tolerance	Efficiency	Dimensions (LxWxH)
YCL150-1050	150W	220-240V AC	1050mA	142V	≥0.9	±5%	92%	191x68x37mm
YCL150-2100	150W	220-240V AC	2100mA	71V	≥0.9	±5%	92%	191x68x37mm
YCL150-3500	150W	220-240V AC	3500mA	42V	≥0.9	±5%	92%	191x68x37mm

**YSCL40 Series**

**220-240V AC**  
Input Voltage

**50/60Hz**  
Input Frequency

**40W**  
Rated Power



- Safety standard: EN61347-1, EN61347-2-13,
- EMI standard: EN55015
- EMS standard: EN61547
- ERP: EU2019/2020
- Protection: Short Circuit/Overload/Over Voltage/Over Temperature
- 100% full load burn in test
- Auto restart after remove of fault conditions
- RoHS Compliance
- IP67

**Dimensions (mm)**

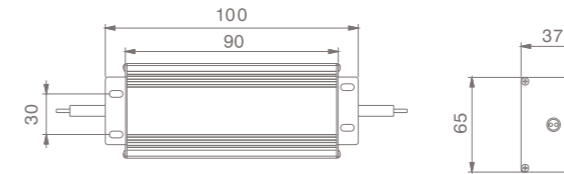

CE SELV RoHS UK

**Waterproof**  
LED Power Supply

40W-350W

**Constant Voltage**

Model	Power (max.)	Input Voltage	Output Voltage	Output Current (max.)	PF	Voltage Tolerance	Efficiency	Dimensions (LxWxH)
YSCL40-12	40W	220-240V AC	12V	3.3A	≥0.9	±5%	90%	100x65x37mm
YSCL40-24	40W	220-240V AC	24V	1.66A	≥0.9	±5%	90%	100x65x37mm
YSCL40-36	40W	220-240V AC	36V	1.11A	≥0.9	±5%	90%	100x65x37mm
YSCL40-48	40W	220-240V AC	48V	0.83A	≥0.9	±5%	90%	100x65x37mm



## YSCL60 Series



**220-240V AC**  
Input Voltage

**50/60Hz**  
Input Frequency

**60W**  
Rated Power

- Safety standard: EN61347-1, EN61347-2-13,
- EMI standard: EN55015
- EMS standard: EN61547
- ERP: EU2019/2020
- Protection: Short Circuit/Overload/Over Voltage/Over Temperature
- 100% full load burn in test
- Auto restart after remove of fault conditions
- RoHS Compliance
- IP67

### Dimensions (mm)

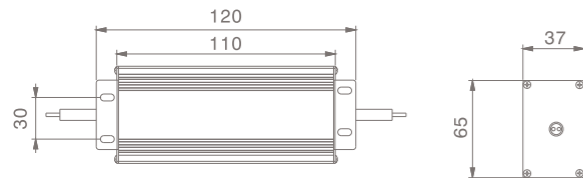

CE SELV RoHS UK

### Constant Voltage

Model	Power (max.)	Input Voltage	Output Voltage	Output Current (max.)	PF	Voltage Tolerance	Efficiency	Dimensions (LxWxH)
YSCL60-12	60W	220-240V AC	12V	5A	≥0.9	±5%	90%	120x65x37mm
YSCL60-24	60W	220-240V AC	24V	2.5A	≥0.9	±5%	90%	120x65x37mm
YSCL60-36	60W	220-240V AC	36V	1.6A	≥0.9	±5%	90%	120x65x37mm
YSCL60-48	60W	220-240V AC	48V	1.25A	≥0.9	±5%	90%	120x65x37mm

## YSCL100 Series



**220-240V AC**  
Input Voltage

**50/60Hz**  
Input Frequency

**100W**  
Rated Power

- Safety standard: EN61347-1, EN61347-2-13,
- EMI standard: EN55015
- EMS standard: EN61547
- ERP: EU2019/2020
- Protection: Short Circuit/Overload/Over Voltage/Over Temperature
- 100% full load burn in test
- Auto restart after remove of fault conditions
- RoHS Compliance
- IP67

### Dimensions (mm)

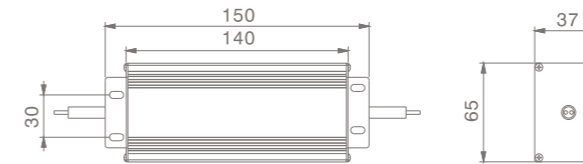

CE SELV RoHS UK

### Constant Voltage

Model	Power (max.)	Input Voltage	Output Voltage	Output Current (max.)	PF	Voltage Tolerance	Efficiency	Dimensions (LxWxH)
YSCL100-12	100W	220-240V AC	12V	8.33A	≥0.95	±5%	92%	150x65x37mm
YSCL100-24	100W	220-240V AC	24V	4.16A	≥0.95	±5%	92%	150x65x37mm
YSCL100-36	100W	220-240V AC	36V	2.77A	≥0.95	±5%	92%	150x65x37mm
YSCL100-48	100W	220-240V AC	48V	2.08A	≥0.95	±5%	92%	150x65x37mm

## YSCL150 Series



**220-240V AC**  
Input Voltage

**50/60Hz**  
Input Frequency

**150W**  
Rated Power

- Safety standard: EN61347-1, EN61347-2-13,
- EMI standard: EN55015
- EMS standard: EN61547
- ERP: EU2019/2020
- Protection: Short Circuit/Overload/Over Voltage/Over Temperature
- 100% full load burn in test
- Auto restart after remove of fault conditions
- RoHS Compliance
- IP67

### Dimensions (mm)

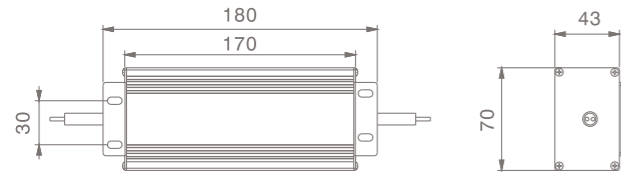

CE SELV RoHS UK

### Constant Voltage

Model	Power (max.)	Input Voltage	Output Voltage	Output Current (max.)	PF	Voltage Tolerance	Efficiency	Dimensions (LxWxH)
YSCL150-12	150W	220-240V AC	12V	12.5A	≥0.95	±5%	92%	180x70x43mm
YSCL150-24	150W	220-240V AC	24V	6.25A	≥0.95	±5%	92%	180x70x43mm
YSCL150-36	150W	220-240V AC	36V	4.16A	≥0.95	±5%	92%	180x70x43mm
YSCL150-48	150W	220-240V AC	48V	3.125A	≥0.95	±5%	92%	180x70x43mm

## YSCL200 Series



**220-240V AC**  
Input Voltage

**50/60Hz**  
Input Frequency

**200W**  
Rated Power

- Safety standard: EN61347-1, EN61347-2-13,
- EMI standard: EN55015
- EMS standard: EN61547
- ERP: EU2019/2020
- Protection: Short Circuit/Overload/Over Voltage/Over Temperature
- 100% full load burn in test
- Auto restart after remove of fault conditions
- RoHS Compliance
- IP67

### Dimensions (mm)

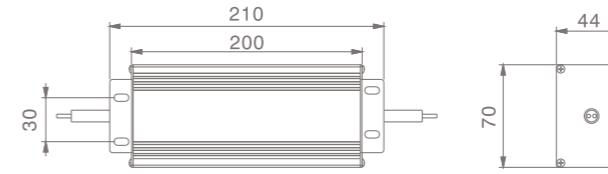

CE SELV RoHS UK

### Constant Voltage

Model	Power (max.)	Input Voltage	Output Voltage	Output Current (max.)	PF	Voltage Tolerance	Efficiency	Dimensions (LxWxH)
YSCL200-12	200W	220-240V AC	12V	16.7A	≥0.95	±5%	92%	210x70x44mm
YSCL200-24	200W	220-240V AC	24V	8.3A	≥0.95	±5%	92%	210x70x44mm
YSCL200-36	200W	220-240V AC	36V	5.55A	≥0.95	±5%	92%	210x70x44mm
YSCL200-48	200W	220-240V AC	48V	4.16A	≥0.95	±5%	92%	210x70x44mm

## YSCL250 Series



**220-240V AC** Input Voltage      **50/60Hz** Input Frequency      **250W** Rated Power

- Safety standard: EN61347-1, EN61347-2-13,
- EMI standard: EN55015
- EMS standard: EN61547
- ERP: EU2019/2020
- Protection: Short Circuit/Overload/Over Voltage/Over Temperature
- 100% full load burn in test
- Auto restart after remove of fault conditions
- RoHS Compliance
- IP67

### Dimensions (mm)

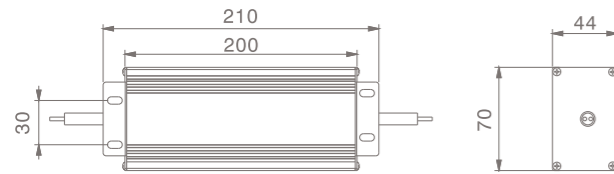

CE SELV RoHS UK

### Constant Voltage

Model	Power (max.)	Input Voltage	Output Voltage	Output Current (max.)	PF	Voltage Tolerance	Efficiency	Dimension (LxWxH)
YSCL250-12	250W	220-240V AC	12V	20.8A	≥0.95	±5%	92%	210x70x44mm
YSCL250-24	250W	220-240V AC	24V	10.4A	≥0.95	±5%	92%	210x70x44mm
YSCL250-36	250W	220-240V AC	36V	40.9A	≥0.95	±5%	92%	210x70x44mm
YSCL250-48	250W	220-240V AC	48V	5.2A	≥0.95	±5%	92%	210x70x44mm

## YSCL360 Series



**220-240V AC** Input Voltage      **50/60Hz** Input Frequency      **350W** Rated Power

- Safety standard: EN61347-1, EN61347-2-13,
- EMI standard: EN55015
- EMS standard: EN61547
- ERP: EU2019/2020
- Protection: Short Circuit/Overload/Over Voltage/Over Temperature
- 100% full load burn in test
- Auto restart after remove of fault conditions
- RoHS Compliance
- IP67

### Dimensions (mm)

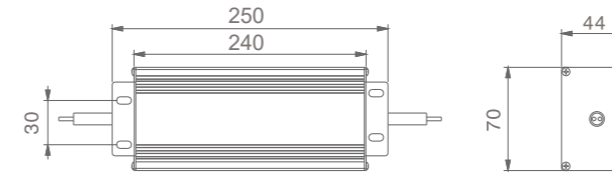

CE SELV RoHS UK

### Constant Voltage

Model	Power (max.)	Input Voltage	Output Voltage	Output Current (max.)	PF	Voltage Tolerance	Efficiency	Dimensions (LxWxH)
YSCL360-12	350W	220-240V AC	12V	29.2A	≥0.95	±5%	90%	250x70x44mm
YSCL360-24	350W	220-240V AC	24V	14.6A	≥0.95	±5%	92%	250x70x44mm
YSCL360-36	350W	220-240V AC	36V	9.7A	≥0.95	±5%	92%	250x70x44mm
YSCL360-48	350W	220-240V AC	48V	7.3A	≥0.95	±5%	92%	250x70x44mm

**DLCV-45 Series**



**Dimmable**  
LED Power Supply

10W-100W

**220-240V AC** Input Voltage      **50/60Hz** Input Frequency      **30/45W** Rated Power

- DALI-2& PUSH ( 2 in 1 ) Dimming
- 0-10V available
- Dimming range:1-100%
- DALI-2 Certified
- Safety standard: EN61347-1, EN61347-2-13,
- EMI standard: EN55015
- EMS standard: EN61547
- ERP: EU2019/2020
- Protection:Short Circuit/Overload/Over Voltage/Over Temperature
- 100% full load burn in test
- Auto restart after remove of fault conditions
- RoHS Compliance

**Dimensions (mm)**

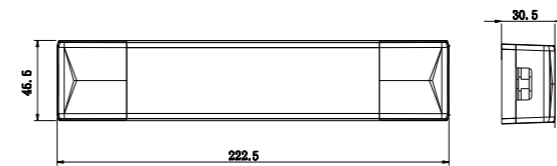

**Constant Voltage**

Model	Power (max.)	Input Voltage	Output Voltage	Output Current (max.)	Voltage Tolerance	Efficiency	Dimensions (LxWxH)	Dimming Type
DLCV-45-12	45W	220-240V AC	12V	3.75A	± 5%	88%	222.5x45.5x30.5mm	Dali&Push
DLCV-45-24	45W	220-240V AC	24V	1.875A	± 5%	88%	222.5x45.5x30.5mm	Dali&Push
DLCV-45-12-V	45W	220-240V AC	12V	3.75A	± 5%	88%	222.5x45.5x30.5mm	0-10V
DLCV-45-24-V	45W	220-240V AC	24V	1.875A	± 5%	88%	222.5x45.5x30.5mm	0-10V

## DLCV-75 Series

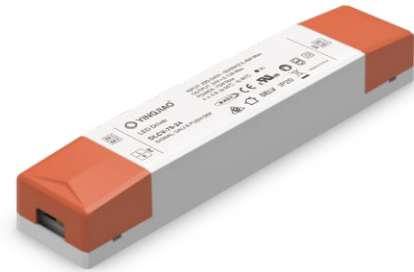

**220-240V AC** Input Voltage      **50/60Hz** Input Frequency      **60/75W** Rated Power

- DALI-2& PUSH ( 2 in 1 ) Dimming
- 0-10V available
- Dimming range:1-100%
- DALI-2 Certified
- Safety standard: EN61347-1, EN61347-2-13,
- EMI standard: EN55015
- EMS standard: EN61547
- ERP: EU2019/2020
- Protection:Short Circuit/Overload/Over Voltage/Over Temperature
- 100% full load burn in test
- Auto restart after remove of fault conditions
- RoHS Compliance

### Dimensions (mm)

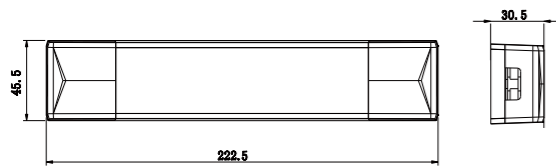

### Constant Voltage

Model	Power (max.)	Input Voltage	Output Voltage	Output Current (max.)	Voltage Tolerance	Efficiency	Dimensions (LxWxH)	Dimming Type
DLCV-75-12	75W	220-240V AC	12V	6.25A	± 5%	88%	222.5x45.5x30.5mm	Dali&Push
DLCV-75-24	75W	220-240V AC	24V	3.125A	± 5%	88%	222.5x45.5x30.5mm	Dali&Push
DLCV-75-36	75W	220-240V AC	36V	2.08A	± 5%	88%	222.5x45.5x30.5mm	Dali&Push
DLCV-75-48	75W	220-240V AC	48V	1.56A	± 5%	88%	222.5x45.5x30.5mm	Dali&Push
DLCV-75-12-V	75W	220-240V AC	12V	6.25A	± 5%	88%	222.5x45.5x30.5mm	0-10V
DLCV-75-24-V	75W	220-240V AC	24V	3.125A	± 5%	88%	222.5x45.5x30.5mm	0-10V
DLCV-75-36-V	75W	220-240V AC	36V	2.08A	± 5%	88%	222.5x45.5x30.5mm	0-10V
DLCV-75-48-V	75W	220-240V AC	48V	1.56A	± 5%	88%	222.5x45.5x30.5mm	0-10V

## DLCV-100 Series



**220-240V AC** Input Voltage      **50/60Hz** Input Frequency      **100W** Rated Power

- DALI-2& PUSH ( 2 in 1 ) Dimming
- 0-10V available
- Dimming range:1-100%
- DALI-2 Certified
- Safety standard: EN61347-1, EN61347-2-13,
- EMI standard: EN55015
- EMS standard: EN61547
- ERP: EU2019/2020
- Protection:Short Circuit/Overload/Over Voltage/Over Temperature
- 100% full load burn in test
- Auto restart after remove of fault conditions
- RoHS Compliance

### Dimensions (mm)

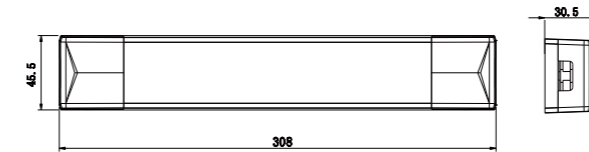

### Constant Voltage

Model	Power (max.)	Input Voltage	Output Voltage	Output Current (max.)	Voltage Tolerance	Efficiency	Dimensions (LxWxH)	Dimming Type
DLCV-100-12	100W	220-240V AC	12V	8.33A	± 5%	90%	308x45.5x30.5mm	Dali&Push
DLCV-100-24	100W	220-240V AC	24V	4.16A	± 5%	90%	308x45.5x30.5mm	Dali&Push
DLCV-100-36	100W	220-240V AC	36V	2.78A	± 5%	90%	308x45.5x30.5mm	Dali&Push
DLCV-100-48	100W	220-240V AC	48V	2.08A	± 5%	90%	308x45.5x30.5mm	Dali&Push
DLCV-100-12-V	100W	220-240V AC	12V	8.33A	± 5%	90%	308x45.5x30.5mm	0-10V
DLCV-100-24-V	100W	220-240V AC	24V	4.16A	± 5%	90%	308x45.5x30.5mm	0-10V
DLCV-100-36-V	100W	220-240V AC	36V	2.78A	± 5%	90%	308x45.5x30.5mm	0-10V
DLCV-100-48-V	100W	220-240V AC	48V	2.08A	± 5%	90%	308x45.5x30.5mm	0-10V

## DLCV-150 Series



**220-240V AC** Input Voltage      **50/60Hz** Input Frequency      **150W** Rated Power

- DALI-2& PUSH ( 2 in 1 ) Dimming
- 0-10V available
- Dimming range:1-100%
- DALI-2 Certified
- Safety standard: EN61347-1, EN61347-2-13,
- EMI standard: EN55015
- EMS standard: EN61547
- ERP: EU2019/2020
- Protection:Short Circuit/Overload/Over Voltage/Over Temperature
- 100% full load burn in test
- Auto restart after remove of fault conditions
- RoHS Compliance

### Dimensions (mm)

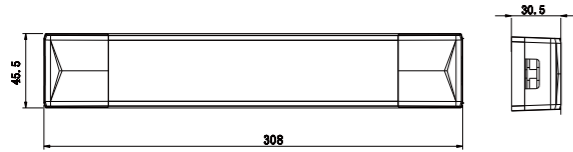

### Constant Voltage

Model	Power (max.)	Input Voltage	Output Voltage	Output Current (max.)	Voltage Tolerance	Efficiency	Dimensions (LxWxH)	Dimming Type
DLCV-150-12	150W	220-240V AC	12V	12.5A	± 5%	92%	308x45.5x30.5mm	Dali&Push
DLCV-150-24	150W	220-240V AC	24V	6.25A	± 5%	92%	308x45.5x30.5mm	Dali&Push
DLCV-150-36	150W	220-240V AC	36V	4.16A	± 5%	92%	308x45.5x30.5mm	Dali&Push
DLCV-150-48	150W	220-240V AC	48V	3.125A	± 5%	92%	308x45.5x30.5mm	Dali&Push
DLCV-150-12-V	150W	220-240V AC	12V	12.5A	± 5%	92%	308x45.5x30.5mm	0-10V
DLCV-150-24-V	150W	220-240V AC	24V	6.25A	± 5%	92%	308x45.5x30.5mm	0-10V
DLCV-150-36-V	150W	220-240V AC	36V	4.16A	± 5%	92%	308x45.5x30.5mm	0-10V
DLCV-150-48-V	150W	220-240V AC	48V	3.125A	± 5%	92%	308x45.5x30.5mm	0-10V

## DLCV-200 Series



**220-240V AC** Input Voltage      **50/60Hz** Input Frequency      **200/250W** Rated Power

- DALI-2& PUSH ( 2 in 1 ) Dimming
- 0-10V available
- Dimming range:1-100%
- DALI-2 Certified
- Safety standard: EN61347-1, EN61347-2-13,
- EMI standard: EN55015
- EMS standard: EN61547
- ERP: EU2019/2020
- Protection:Short Circuit/Overload/Over Voltage/Over Temperature
- 100% full load burn in test
- Auto restart after remove of fault conditions
- RoHS Compliance

### Dimensions (mm)

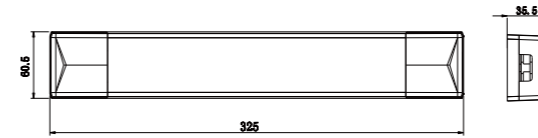

### Constant Voltage

Model	Power (max.)	Input Voltage	Output Voltage	Output Current (max.)	Voltage Tolerance	Efficiency	Dimensions (LxWxH)	Dimming Type
DLCV-200-12	200W	220-240V AC	12V	16.67A	± 5%	94%	325x60.5x35.5mm	Dali&Push
DLCV-200-24	200W	220-240V AC	24V	8.33A	± 5%	94%	325x60.5x35.5mm	Dali&Push
DLCV-200-36	200W	220-240V AC	36V	5.56A	± 5%	94%	325x60.5x35.5mm	Dali&Push
DLCV-200-48	200W	220-240V AC	48V	4.16A	± 5%	94%	325x60.5x35.5mm	Dali&Push
DLCV-250-12	250W	220-240V AC	12V	20.83A	± 5%	94%	325x60.5x35.5mm	Dali&Push
DLCV-250-24	250W	220-240V AC	24V	10.4A	± 5%	94%	325x60.5x35.5mm	Dali&Push
DLCV-250-36	250W	220-240V AC	36V	6.94A	± 5%	94%	325x60.5x35.5mm	Dali&Push
DLCV-250-48	250W	220-240V AC	48V	5.2A	± 5%	94%	325x60.5x35.5mm	Dali&Push

**DLCC-20 Series** Dipswitch  
NFC

**DLCC-40 Series** Dipswitch  
NFC



**220-240V AC** Input Voltage  
**50/60Hz** Input Frequency  
**20W** Rated Power

**220-240V AC** Input Voltage  
**50/60Hz** Input Frequency  
**40W** Rated Power

- DALI-2& PUSH ( 2 in 1 ) Dimming
- Adjustable Output Current with dip-switch
- Adjustable Output Current with NFC
- DALI-2 Certified
- Safety standard: EN61347-1, EN61347-2-13,
- EMI standard: EN55015
- EMS standard: EN61547
- ERP: EU2019/2020
- Protection: Short Circuit/Overload/Over Voltage/Over Temperature
- 100% full load burn in test
- Auto restart after remove of fault conditions
- RoHS Compliance

- DALI-2& PUSH ( 2 in 1 ) Dimming
- Adjustable Output Current with dip-switch
- Adjustable Output Current with NFC
- DALI-2 Certified
- Safety standard: EN61347-1, EN61347-2-13,
- EMI standard: EN55015
- EMS standard: EN61547
- ERP: EU2019/2020
- Protection: Short Circuit/Overload/Over Voltage/Over Temperature
- 100% full load burn in test
- Auto restart after remove of fault conditions
- RoHS Compliance

**Dimensions (mm)**

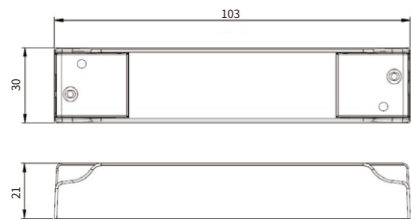

**Dimensions (mm)**

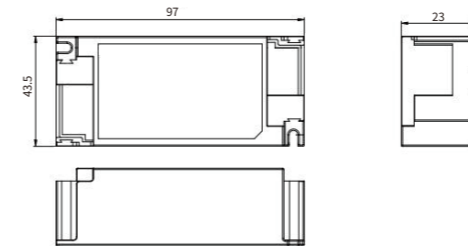

**Constant Current**

Model	Power (max.)	Input Voltage	Output Current	Output Voltage (max.)	PF	Voltage Tolerance	Efficiency	Dimensions (LxWxH)
DLCC-20	20W	220-240V AC	150-700mA	9V-42V	≥0.9	±5%	88%	103x30x21mm

**Constant Current**

Model	Power (max.)	Input Voltage	Output Current	Output Voltage (max.)	PF	Voltage Tolerance	Efficiency	Dimensions (LxWxH)
DLCC-40	40W	220-240V AC	150-700mA	9V-42V	≥0.9	±5%	88%	97x43.5x23mm
DLCC-40	40W	220-240V AC	700-1050mA	9V-42V	≥0.9	±5%	88%	97x43.5x23mm

**DLCC-60 Series**

Dipswitch  
NFC



**220-240V AC**  
Input Voltage

**50/60Hz**  
Input Frequency

**60W**  
Rated Power

- DALI-2& PUSH ( 2 in 1 ) Dimming
- Adjustable Output Current with dip-switch
- Adjustable Output Current with NFC
- DALI-2 Certified
- Safety standard: EN61347-1, EN61347-2-13,
- EMI standard: EN55015
- EMS standard: EN61547
- ERP: EU2019/2020
- Protection: Short Circuit/Overload/Over Voltage/Over Temperature
- 100% full load burn in test
- Auto restart after remove of fault conditions
- RoHS Compliance



**Dimensions (mm)**

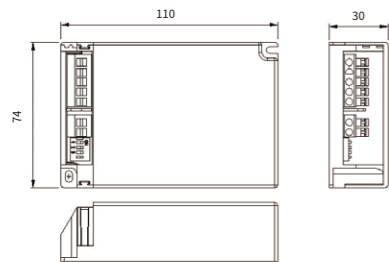

**Constant Current**

Model	Power (max.)	Input Voltage	Output Current	Output Voltage (max.)	PF	Voltage Tolerance	Efficiency	Dimensions (LxWxH)
DLCC-60	60W	220-240V AC	100-700mA	9V-52V	≥0.9	±5%	88%	110x74x30mm
DLCC-60	60W	220-240V AC	700-1400mA	9V-52V	≥0.9	±5%	88%	110x74x30mm

**YSL15-D Series**

TRIAC Dimming Mode



**220-240V AC**  
Input Voltage

**50/60Hz**  
Input Frequency

**10W**  
Rated Power

- Dimming with leading edge and trailing edge
- Smooth dimming compatible with most dimmers
- Safety standard: EN61347-1, EN61347-2, UL8750+1310
- EMI standard: EN55015
- EMS standard: EN61547
- Harmonic: EN61000-3-2
- Directive 2009/125/EC
- ERP: EU2019/2020
- Protection: Short Circuit/Overload/Over Voltage/Over Temperature
- 100% full load burn in test
- Auto restart after remove of fault conditions
- RoHS Compliance



**Dimensions (mm)**

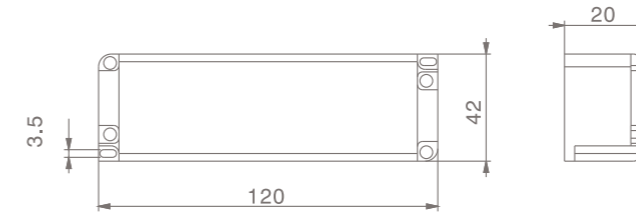

**Constant Current**

Model	Power (max.)	Input Voltage	Output Current	Output Voltage	PF	Voltage Tolerance	Efficiency	Dimensions (LxWxH)
YSL15D-350	10W	220-240V AC	350mA	16-18V	≥0.9	±5%	85%	120x42x20mm
YSL15D-500	10W	220-240V AC	500mA	10-20V	≥0.9	±5%	85%	120x42x20mm
YSL15D-700	10W	220-240V AC	700mA	8-14V	≥0.9	±5%	85%	120x42x20mm



## YSL36-D Series

TRIAC Dimming Mode



**220-240V AC**  
Input Voltage

**50/60Hz**  
Input Frequency

**18W**  
Rated Power

- Dimming with leading edge and trailing edge
- Smooth dimming compatible with most dimmers
- Safety standard: EN61347-1, EN61347-2, UL8750+1310
- EMI standard: EN55015
- EMS standard: EN61547
- Harmonic: EN61000-3-2
- Directive 2009/125/EC
- ERP: EU2019/2020
- Protection: Short Circuit/Overload/Over Voltage/Over Temperature
- 100% full load burn in test
- Auto restart after remove of fault conditions
- RoHS Compliance

CE SELV RoHS UK

### Dimensions (mm)

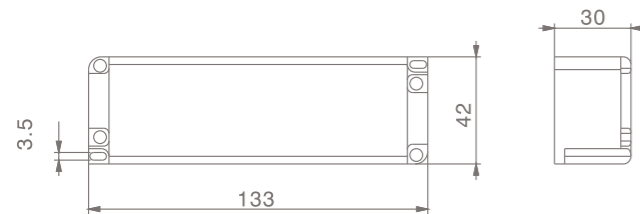

### Constant Current

Model	Power (max.)	Input Voltage	Output Current	Output Voltage (max.)	PF	Voltage Tolerance	Efficiency	Dimensions (LxWxH)
YSL36D-350	18W	220-240V AC	350mA	40-51V	≥0.9	±5%	85%	133x42x30mm
YSL36D-500	18W	220-240V AC	500mA	30-36V	≥0.9	±5%	85%	133x42x30mm
YSL36D-700	18W	220-240V AC	700mA	20-25V	≥0.9	±5%	85%	133x42x30mm

## YSL80-D Series

TRIAC Dimming Mode



**220-240V AC**  
Input Voltage

**50/60Hz**  
Input Frequency

**40W**  
Rated Power

- Dimming with leading edge and trailing edge
- Smooth dimming compatible with most dimmers
- Safety standard: EN61347-1, EN61347-2, UL8750+1310
- EMI standard: EN55015
- EMS standard: EN61547
- Harmonic: EN61000-3-2
- Directive 2009/125/EC
- ERP: EU2019/2020
- Protection: Short Circuit/Overload/Over Voltage/Over Temperature
- 100% full load burn in test
- Auto restart after remove of fault conditions
- RoHS Compliance

CE SELV RoHS UK

### Dimensions (mm)

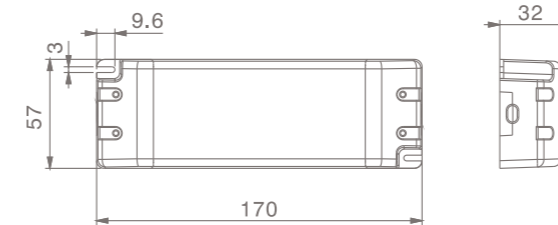

### Constant Voltage

Model	Power (max.)	Input Voltage	Output Voltage	Output Current (max.)	PF	Voltage Tolerance	Efficiency	Dimensions (LxWxH)
YSL80-D	40W	220-240V AC	12V	3.33A	≥0.9	±5%	85%	170x57x32mm
YSL80-D	40W	220-240V AC	24V	1.66A	≥0.9	±5%	85%	170x57x32mm

### Constant Current

Model	Power (max.)	Input Voltage	Output Current	Output Voltage (max.)	PF	Voltage Tolerance	Efficiency	Dimensions (LxWxH)
YSL80-D	40W	220-240V AC	700mA	40-57V	≥0.9	±5%	85%	170x57x32mm
YSL80-D	40W	220-240V AC	1050mA	30-38V	≥0.9	±5%	85%	170x57x32mm

## YSL100-D Series

TRIAC Dimming Mode



**220-240V AC**  
Input Voltage

**50/60Hz**  
Input Frequency

**50W**  
Rated Power

- Dimming with leading edge and trailing edge
- Smooth dimming compatible with most dimmers
- Safety standard: EN61347-1, EN61347-2, UL8750+1310
- EMI standard: EN55015
- EMS standard: EN61547
- Harmonic: EN61000-3-2
- Directive 2009/125/EC
- ERP: EU2019/2020
- Protection: Short Circuit/Overload/Over Voltage/Over Temperature
- 100% full load burn in test
- Auto restart after remove of fault conditions
- RoHS Compliance

CE SELV RoHS UK

### Dimensions (mm)

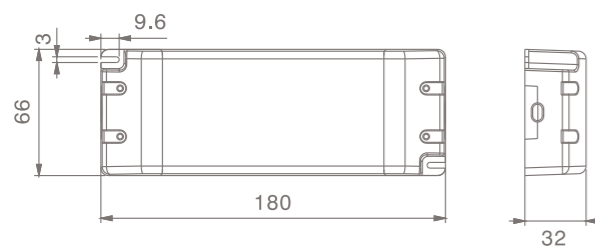

### Constant Voltage

Model	Power (max.)	Input Voltage	Output Voltage	Output Current (max.)	PF	Voltage Tolerance	Efficiency	Dimensions (LxWxH)
YSL100-D	50W	220-240V AC	12V	4.16A	≥0.9	±5%	85%	180x66x32mm
YSL100-D	50W	220-240V AC	24V	2.08A	≥0.9	±5%	85%	180x66x32mm
YSL100-D	50W	220-240V AC	48V	1.05A	≥0.9	±5%	85%	180x66x32mm

## YSL150-D Series

TRIAC Dimming Mode



**220-240V AC**  
Input Voltage

**50/60Hz**  
Input Frequency

**75/100W**  
Rated Power

- Dimming with leading edge and trailing edge
- Smooth dimming compatible with most dimmers
- Safety standard: EN61347-1, EN61347-2, UL8750+1310
- EMI standard: EN55015
- EMS standard: EN61547
- Harmonic: EN61000-3-2
- Directive 2009/125/EC
- ERP: EU2019/2020
- Protection: Short Circuit/Overload/Over Voltage/Over Temperature
- 100% full load burn in test
- Auto restart after remove of fault conditions
- RoHS Compliance

CE SELV RoHS UK

### Dimensions (mm)

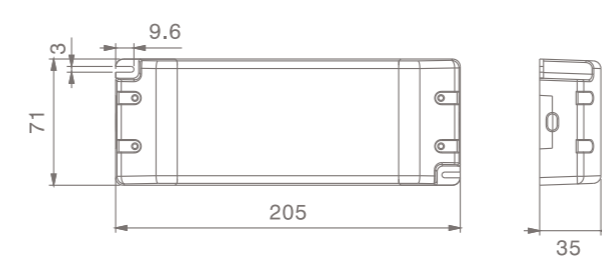

### Constant Voltage

Model	Power (max.)	Input Voltage	Output Voltage	Output Current (max.)	PF	Voltage Tolerance	Efficiency	Dimensions (LxWxH)
YSL150-D	100W	220-240V AC	12V	8.3A	≥0.9	±5%	85%	205x71x35mm
YSL150-D	100W	220-240V AC	24V	4.16A	≥0.9	±5%	85%	205x71x35mm
YSL150-D	100W	220-240V AC	36V	2.7A	≥0.9	±5%	85%	205x71x35mm
YSL150-D	100W	220-240V AC	48V	2.08A	≥0.9	±5%	85%	205x71x35mm

## YSCL30DV Series

Push Dimming



**220-240V AC**  
Input Voltage

**50/60Hz**  
Input Frequency

**30W**  
Rated Power

- Push dimming constant voltage drivers
- Push Dimming
- Safety standard: EN61347-1, EN61347-2-13,
- EMI standard: EN55015
- EMS standard: EN61547
- ERP: EU2019/2020
- Protection: Short Circuit/Overload/Over Voltage/Over Temperature
- 100% full load burn in test
- Auto restart after remove of fault conditions
- RoHS Compliance

### Dimensions (mm)

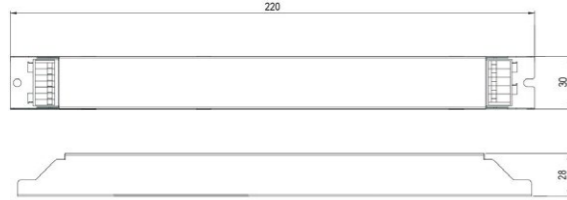

CE SELV RoHS UK

### Constant Voltage

Model	Power (max.)	Input Voltage	Output Voltage	Output Current (max.)	PF	Voltage Tolerance	Efficiency	Dimensions (LxWxH)
YSCL30DV-12	30W	220-240V AC	12V	2.5A	≥0.9	± 5%	92%	220x30x28mm
YSCL30DV-24	30W	220-240V AC	24V	1.25A	≥0.9	± 5%	92%	220x30x28mm
YSCL30DV-36	30W	220-240V AC	36V	0.83A	≥0.9	± 5%	92%	220x30x28mm
YSCL30DV-48	30W	220-240V AC	48V	0.625A	≥0.9	± 5%	92%	220x30x28mm

## YSCL60DV Series

Push Dimming



**220-240V AC**  
Input Voltage

**50/60Hz**  
Input Frequency

**60W**  
Rated Power

- Push dimming constant voltage drivers
- Push Dimming
- Safety standard: EN61347-1, EN61347-2-13,
- EMI standard: EN55015
- EMS standard: EN61547
- ERP: EU2019/2020
- Protection: Short Circuit/Overload/Over Voltage/Over Temperature
- 100% full load burn in test
- Auto restart after remove of fault conditions
- RoHS Compliance

### Dimensions (mm)

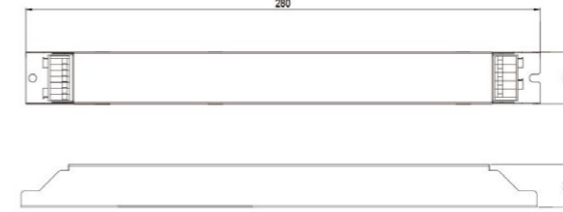

CE SELV RoHS UK

### Constant Voltage

Model	Power (max.)	Input Voltage	Output Voltage	Output Current (max.)	PF	Voltage Tolerance	Efficiency	Dimensions (LxWxH)
YSCL60DV-12	60W	220-240V AC	12V	5A	≥0.9	± 5%	92%	280x30x28mm
YSCL60DV-24	60W	220-240V AC	24V	2.5A	≥0.9	± 5%	92%	280x30x28mm
YSCL60DV-36	60W	220-240V AC	36V	1.67A	≥0.9	± 5%	92%	280x30x28mm
YSCL60DV-48	60W	220-240V AC	48V	1.25A	≥0.9	± 5%	92%	280x30x28mm

## YSCL100DV Series

Push Dimming



**220-240V AC**  
Input Voltage

**50/60Hz**  
Input Frequency

**100W**  
Rated Power

- Push dimming constant voltage drivers
- Push Dimming
- Safety standard: EN61347-1, EN61347-2-13,
- EMI standard: EN55015
- EMS standard: EN61547
- ERP: EU2019/2020
- Protection: Short Circuit/Overload/Over Voltage/Over Temperature
- 100% full load burn in test
- Auto restart after remove of fault conditions
- RoHS Compliance

### Dimensions (mm)

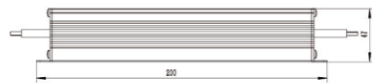

CE SELV RoHS UK

### Constant Voltage

Model	Power (max.)	Input Voltage	Output Voltage	Output Current (max.)	PF	Voltage Tolerance	Efficiency	Dimensions (LxWxH)
YSCL100DV-12	100W	220-240V AC	12V	8.33A	≥0.9	±5%	92%	200x70x47mm
YSCL100DV-24	100W	220-240V AC	24V	4.16A	≥0.9	±5%	92%	200x70x47mm
YSCL100DV-36	100W	220-240V AC	36V	2.78A	≥0.9	±5%	92%	200x70x47mm
YSCL100DV-48	100W	220-240V AC	48V	2.08A	≥0.9	±5%	92%	200x70x47mm

## YSCL150DV Series

Push Dimming



**220-240V AC**  
Input Voltage

**50/60Hz**  
Input Frequency

**150W**  
Rated Power

- Push dimming constant voltage drivers
- Push Dimming
- Safety standard: EN61347-1, EN61347-2-13,
- EMI standard: EN55015
- EMS standard: EN61547
- ERP: EU2019/2020
- Protection: Short Circuit/Overload/Over Voltage/Over Temperature
- 100% full load burn in test
- Auto restart after remove of fault conditions
- RoHS Compliance

### Dimensions (mm)

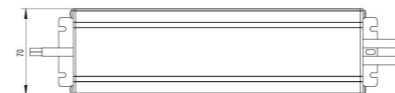
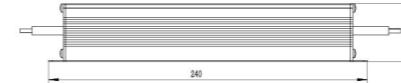

CE SELV RoHS UK

### Constant Voltage

Model	Power (max.)	Input Voltage	Output Voltage	Output Current (max.)	PF	Voltage Tolerance	Efficiency	Dimensions (LxWxH)
YSCL150DV-12	150W	220-240V AC	12V	12.5A	≥0.9	±5%	92%	240x70x47mm
YSCL150DV-24	150W	220-240V AC	24V	6.25A	≥0.9	±5%	92%	240x70x47mm
YSCL150DV-36	150W	220-240V AC	36V	4.16A	≥0.9	±5%	92%	240x70x47mm
YSCL150DV-48	150W	220-240V AC	48V	3.125A	≥0.9	±5%	92%	240x70x47mm

## YSCL200DV Series

Push Dimming



**220-240V AC**  
Input Voltage

**50/60Hz**  
Input Frequency

**200W**  
Rated Power

- Push dimming constant voltage drivers
- Push Dimming
- Safety standard: EN61347-1, EN61347-2-13,
- EMI standard: EN55015
- EMS standard: EN61547
- ERP: EU2019/2020
- Protection: Short Circuit/Overload/Over Voltage/Over Temperature
- 100% full load burn in test
- Auto restart after remove of fault conditions
- RoHS Compliance

### Dimensions (mm)

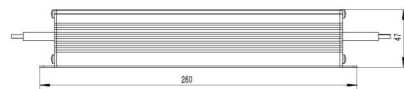

CE SELV RoHS UK

### Constant Voltage

Model	Power (max.)	Input Voltage	Output Voltage	Output Current (max.)	PF	Voltage Tolerance	Efficiency	Dimensions (LxWxH)
YSCL200DV-12	200W	220-240V AC	12V	16.67A	≥0.9	± 5%	92%	260x70x47mm
YSCL200DV-24	200W	220-240V AC	24V	8.33A	≥0.9	± 5%	92%	260x70x47mm
YSCL200DV-36	200W	220-240V AC	36V	5.56A	≥0.9	± 5%	92%	260x70x47mm
YSCL200DV-48	200W	220-240V AC	48V	4.16A	≥0.9	± 5%	92%	260x70x47mm

## YSCL300DV Series

Push Dimming



**220-240V AC**  
Input Voltage

**50/60Hz**  
Input Frequency

**300W**  
Rated Power

- Push dimming constant voltage drivers
- Push Dimming
- Safety standard: EN61347-1, EN61347-2-13,
- EMI standard: EN55015
- EMS standard: EN61547
- ERP: EU2019/2020
- Protection: Short Circuit/Overload/Over Voltage/Over Temperature
- 100% full load burn in test
- Auto restart after remove of fault conditions
- RoHS Compliance

### Dimensions (mm)

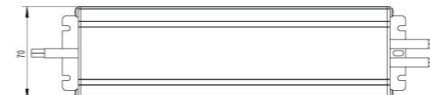
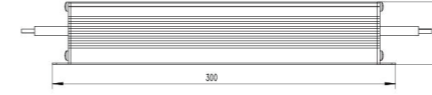

CE SELV RoHS UK

### Constant Voltage

Model	Power (max.)	Input Voltage	Output Voltage	Output Current (max.)	PF	Voltage Tolerance	Efficiency	Dimensions (LxWxH)
YSCL300DV-12	300W	220-240V AC	12V	25A	≥0.9	± 5%	92%	300x70x47mm
YSCL300DV-24	300W	220-240V AC	24V	12.5A	≥0.9	± 5%	92%	300x70x47mm
YSCL300DV-36	300W	220-240V AC	36V	8.33A	≥0.9	± 5%	92%	300x70x47mm
YSCL300DV-48	300W	220-240V AC	48V	6.25A	≥0.9	± 5%	92%	300x70x47mm

**SLCV-40 Series**

**100-277V AC**  
Input Voltage

**50/60Hz**  
Input Frequency

**40W**  
Rated Power



- LINEAGE Constant Voltage Drivers
- Safety standard: EN61347-1, EN61347-2-13,
- UL8750+1310 CAN/CSA C22.2 No.250.13
- FCC CFR Title 47 Part 15
- EMI standard: EN55015
- EMS standard: EN61547
- ERP: EU2019/2020
- Protection: Short Circuit/Overload/Over Voltage/Over Temperature
- 100% full load burn in test
- Auto restart after remove of fault conditions
- RoHS Compliance
- UL Class P

**Dimensions (mm)**

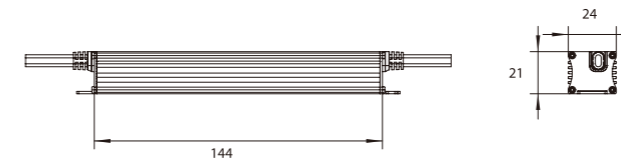

**Constant Voltage**

Model	Power (max.)	Input Voltage	Output Voltage	Output Current (max.)	Voltage Tolerance	Ripple (P-P)	Efficiency	Dimensions (LxWxH)
SLCV-40-12	40W	100-277V AC	12V	3.3A	± 5%	< 1%	88%	144x24x21mm
SLCV-40-24	40W	100-277V AC	24V	1.67A	± 5%	< 1%	88%	144x24x21mm
SLCV-40-36	40W	100-277V AC	36V	1.11A	± 5%	< 1%	88%	144x24x21mm
SLCV-40-48	40W	100-277V AC	48V	0.83A	± 5%	< 1%	88%	144x24x21mm

**LINEAGE Series  
Constant Voltage  
Drivers**

**DRIVE** SMART LIGHTING

## SLCV-60 Series



**100-277V AC**  
Input Voltage

**50/60Hz**  
Input Frequency

**60W**  
Rated Power

- LINEAGE Constant Voltage Drivers
- Safety standard: EN61347-1, EN61347-2-13,
- UL8750+1310 CAN/CSA C22.2 No.250.13
- FCC CFR Title 47 Part 15
- EMI standard: EN55015
- EMS standard: EN61547
- ERP: EU2019/2020
- Protection: Short Circuit/Overload/Over Voltage/Over Temperature
- 100% full load burn in test
- Auto restart after remove of fault conditions
- RoHS Compliance
- UL Class P

### Dimensions (mm)

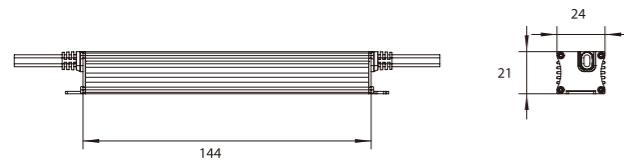

### Constant Voltage

Model	Power (max.)	Input Voltage	Output Voltage	Output Current (max.)	Voltage Tolerance	Ripple (P-P)	Efficiency	Dimensions (LxWxH)
SLCV-60-12	60W	100-277V AC	12V	5A	± 5%	< 1%	88%	144x24x21mm
SLCV-60-24	60W	100-277V AC	24V	2.5A	± 5%	< 1%	88%	144x24x21mm
SLCV-60-36	60W	100-277V AC	36V	1.67A	± 5%	< 1%	88%	144x24x21mm
SLCV-60-48	60W	100-277V AC	48V	1.25A	± 5%	< 1%	88%	144x24x21mm

## SLCV-100 Series



**100-277V AC**  
Input Voltage

**50/60Hz**  
Input Frequency

**100W**  
Rated Power

- LINEAGE Constant Voltage Drivers
- Safety standard: EN61347-1, EN61347-2-13,
- UL8750+1310 CAN/CSA C22.2 No.250.13
- FCC CFR Title 47 Part 15
- EMI standard: EN55015
- EMS standard: EN61547
- ERP: EU2019/2020
- Protection: Short Circuit/Overload/Over Voltage/Over Temperature
- 100% full load burn in test
- Auto restart after remove of fault conditions
- RoHS Compliance
- UL Class P

### Dimensions (mm)

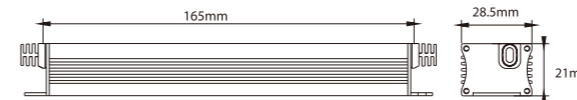

### Constant Voltage

Model	Power (max.)	Input Voltage	Output Voltage	Output Current (max.)	Voltage Tolerance	Ripple (P-P)	Efficiency	Dimensions (LxWxH)
SLCV-100-12	100W	100-277V AC	12V	8.3A	± 5%	< 1%	91%	165x28.5x21mm
SLCV-100-24	100W	100-277V AC	24V	4.16A	± 5%	< 1%	91%	165x28.5x21mm
SLCV-100-36	100W	100-277V AC	36V	2.7A	± 5%	< 1%	91%	165x28.5x21mm
SLCV-100-48	100W	100-277V AC	48V	2.08A	± 5%	< 1%	91%	165x28.5x21mm

### SLCV-60-D Series

0-10V Dimming



**100-277V AC**  
Input Voltage

**50/60Hz**  
Input Frequency

**40/60W**  
Rated Power

- LINEAGE 0-10V Dimming Constant Voltage Drivers
- 0-10V Dimming
- Dimming range: 1-100%
- Safety standard: EN61347-1, EN61347-2-13,
- UL8750+1310 CAN/CSA C22.2 No.250.13
- FCC CFR Title 47 Part 15
- EMI standard: EN55015
- EMS standard: EN61547
- ERP: EU2019/2020
- Protection: Short Circuit/Overload/Over Voltage/Over Temperature
- 100% full load burn in test
- Auto restart after remove of fault conditions
- RoHS Compliance

#### Dimensions (mm)

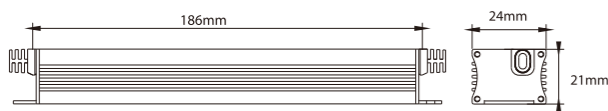

#### Constant Voltage

Model	Power (max.)	Input Voltage	Output Voltage	Output Current (max.)	Voltage Tolerance	Ripple (P-P)	Efficiency	Dimensions (LxWxH)
SLCV-40-12-D	40W	100-277V AC	12V	3.3A	± 5%	< 1%	88%	186x24x21mm
SLCV-40-24-D	40W	100-277V AC	24V	1.67A	± 5%	< 1%	88%	186x24x21mm
SLCV-40-36-D	40W	100-277V AC	36V	1.11A	± 5%	< 1%	88%	186x24x21mm
SLCV-40-48-D	40W	100-277V AC	48V	0.83A	± 5%	< 1%	88%	186x24x21mm
SLCV-60-12-D	60W	100-277V AC	12V	5A	± 5%	< 1%	88%	186x24x21mm
SLCV-60-24-D	60W	100-277V AC	24V	2.5A	± 5%	< 1%	88%	186x24x21mm
SLCV-60-36-D	60W	100-277V AC	36V	1.67A	± 5%	< 1%	88%	186x24x21mm
SLCV-60-48-D	60W	100-277V AC	48V	1.25A	± 5%	< 1%	88%	186x24x21mm

### SLCV-100-D Series

0-10V Dimming



**100-277V AC**  
Input Voltage

**50/60Hz**  
Input Frequency

**100W**  
Rated Power

- LINEAGE 0-10V Dimming Constant Voltage Drivers
- 0-10V Dimming
- Dimming range: 1-100%
- Safety standard: EN61347-1, EN61347-2-13,
- UL8750+1310 CAN/CSA C22.2 No.250.13
- FCC CFR Title 47 Part 15
- EMI standard: EN55015
- EMS standard: EN61547
- ERP: EU2019/2020
- Protection: Short Circuit/Overload/Over Voltage/Over Temperature
- 100% full load burn in test
- Auto restart after remove of fault conditions
- RoHS Compliance

#### Dimensions (mm)

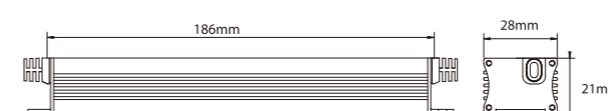

#### Constant Voltage

Model	Power (max.)	Input Voltage	Output Voltage	Output Current (max.)	Voltage Tolerance	Ripple (P-P)	Efficiency	Dimensions (LxWxH)
SLCV-100-12-D	72W	100-277V AC	12V	6A	± 5%	< 1%	92%	186x28x21mm
SLCV-100-24-D	72W	100-277V AC	24V	3A	± 5%	< 1%	92%	186x28x21mm
SLCV-100-36-D	72W	100-277V AC	36V	2A	± 5%	< 1%	92%	186x28x21mm
SLCV-100-48-D	72W	100-277V AC	48V	1.5A	± 5%	< 1%	92%	186x28x21mm
SLCV-100-12-D	100W	100-277V AC	12V	8.3A	± 5%	< 1%	92%	186x28x21mm
SLCV-100-24-D	100W	100-277V AC	24V	4.16A	± 5%	< 1%	92%	186x28x21mm
SLCV-100-36-D	100W	100-277V AC	36V	2.7A	± 5%	< 1%	92%	186x28x21mm
SLCV-100-48-D	100W	100-277V AC	48V	2.08A	± 5%	< 1%	92%	186x28x21mm



## PDCC-30 Series



**100-277V AC**  
Input Voltage

**50/60Hz**  
Input Frequency

**30W**  
Rated Power

- Programmable 0-10V Dimming
- Dimming range: 1-100%
- Safety standard: EN61347-1, EN61347-2-13,
- UL8750+1310 CAN/CSA C22.2 No.250.13
- FCC CFR Title 47 Part 15
- EMI standard: EN55015
- EMS standard: EN61547
- ERP: EU2019/2020
- Protection: Short Circuit/Overload/Over Voltage/Over Temperature
- 100% full load burn in test
- Auto restart after remove of fault conditions
- RoHS Compliance

### Dimensions (mm)

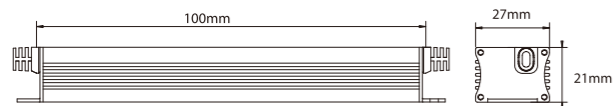

### Constant Voltage

Model	Power (max.)	Input Voltage	Output Current	Default Programmed Current	Output Voltage (max.)	Ripple (P-P)	Efficiency	Dimensions (LxWxH)
PDCC-30-0500-24	12W	100-277V AC	300-500mA	350mA	24V	< 1%	88%	100x27x21mm
PDCC-30-0700-21	15W	100-277V AC	400-700mA	500mA	21V	< 1%	88%	100x27x21mm
PDCC-30-0500-50	20W	100-277V AC	300-500mA	350mA	42V	< 1%	88%	100x27x21mm
PDCC-30-0500-60	30W	100-277V AC	300-500mA	350mA	60V	< 1%	88%	100x27x21mm
PDCC-30-0700-42	30W	100-277V AC	400-700mA	500mA	42V	< 1%	88%	100x27x21mm
PDCC-30-0900-33	30W	100-277V AC	600-900mA	700mA	33V	< 1%	88%	100x27x21mm

\* Output current can be customized

## PDCC-50 Series



**100-277V AC**  
Input Voltage

**50/60Hz**  
Input Frequency

**50W**  
Rated Power

- Programmable 0-10V Dimming
- Dimming range: 1-100%
- Safety standard: EN61347-1, EN61347-2-13,
- UL8750+1310 CAN/CSA C22.2 No.250.13
- FCC CFR Title 47 Part 15
- EMI standard: EN55015
- EMS standard: EN61547
- ERP: EU2019/2020
- Protection: Short Circuit/Overload/Over Voltage/Over Temperature
- 100% full load burn in test
- Auto restart after remove of fault conditions
- RoHS Compliance

### Dimensions (mm)

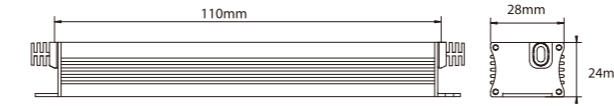

### Constant Voltage

Model	Power (max.)	Input Voltage	Output Current	Default Programmed Current	Output Voltage (max.)	Ripple (P-P)	Efficiency	Dimensions (LxWxH)
PDCC-50-0700-42	30W	100-277V AC	300-700mA	350mA	27V	< 1%	88%	110x28x24mm
PDCC-50-1000-30	30W	100-277V AC	500-1000mA	700mA	30V	< 1%	88%	110x28x24mm
PDCC-50-1400-27	38W	100-277V AC	700-1400mA	1050mA	27V	< 1%	88%	110x28x24mm
PDCC-50-0700-71	50W	100-277V AC	300-700mA	500mA	71V	< 1%	88%	110x28x24mm
PDCC-50-0900-55	50W	100-277V AC	600-900mA	700mA	55V	< 1%	88%	110x28x24mm
PDCC-50-1400-35	50W	100-277V AC	1000-1400mA	1200mA	35V	< 1%	88%	110x28x24mm

\* Output current can be customized

## CDCP-40 Series



**100-277V AC**  
Input Voltage

**50/60Hz**  
Input Frequency

**40W**  
Rated Power

- PINNACEL Tri-Mode Dimming Constant Current Drivers
- Compatible with TRIAC (forward-phase or leading-edge) / ELV (reverse-phase or trailing-edge) and 0-10 V dimmers
- Dimming range:5-100%
- Safety standard: EN61347-1, EN61347-2-13, UL8750+1310 CAN/CSA C22.2 No.250.13
- FCC CFR Title 47 Part 15
- EMI standard: EN55015
- EMS standard: EN61547
- ERP: EU2019/2020
- Protection:Short Circuit/Overload/Over Voltage/Over Temperature
- 100% full load burn in test
- Auto restart after remove of fault conditions
- RoHS Compliance

### Dimensions (mm)

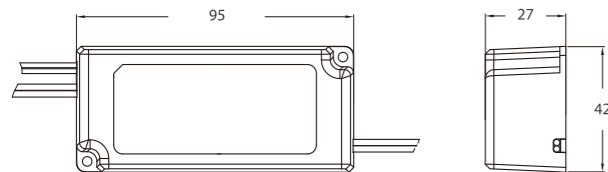

### Constant Current

Model	Power (max.)	Input Voltage	Output Current	Output Voltage (max.)	Voltage Tolerance	Ripple (P-P)	Efficiency	Dimensions (LxWxH)
CDCP-40-0700-28	20W	100-277V AC	700mA	28V	± 5%	< 1%	85%	95x42x27mm
CDCP-40-0900-33	30W	100-277V AC	900mA	33V	± 5%	< 1%	85%	95x42x27mm
CDCP-40-0800-50	40W	100-277V AC	800mA	50V	± 5%	< 1%	85%	95x42x27mm
CDCP-40-0900-44	40W	100-277V AC	900mA	44V	± 5%	< 1%	85%	95x42x27mm
CDCP-40-1400-28	40W	100-277V AC	1400mA	28V	± 5%	< 1%	85%	95x42x27mm

\* Output current can be customized

## CDCP-60 Series



**100-277V AC**  
Input Voltage

**50/60Hz**  
Input Frequency

**60W**  
Rated Power

- PINNACEL Tri-Mode Dimming Constant Current Drivers
- Compatible with TRIAC (forward-phase or leading-edge) / ELV (reverse-phase or trailing-edge) and 0-10 V dimmers
- TRIAC and ELV dimming only at 120 Vac
- Dimming range:5-100%
- Safety standard: EN61347-1, EN61347-2-13, UL8750+1310 CAN/CSA C22.2 No.250.13
- FCC CFR Title 47 Part 15
- EMI standard: EN55015
- EMS standard: EN61547
- ERP: EU2019/2020
- Protection:Short Circuit/Overload/Over Voltage/Over Temperature
- 100% full load burn in test
- Auto restart after remove of fault conditions
- RoHS Compliance

### Dimensions (mm)

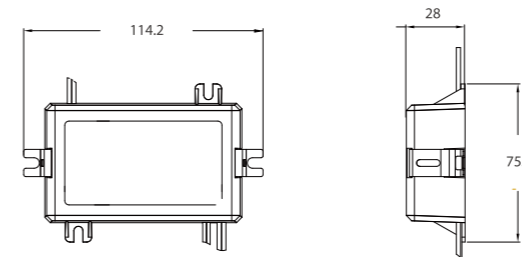

### Constant Current

Model	Power (max.)	Input Voltage	Output Current	Output Voltage (max.)	Voltage Tolerance	Ripple (P-P)	Efficiency	Dimensions (LxWxH)
CDCP-60-0700-42	30W	100-277V AC	700mA	42V	± 5%	< 1%	85%	114.2x75.5x28mm
CDCP-60-0900-44	40W	100-277V AC	900mA	44V	± 5%	< 1%	85%	114.2x75.5x28mm
CDCP-60-0800-62	50W	100-277V AC	800mA	62V	± 5%	< 1%	85%	114.2x75.5x28mm
CDCP-60-1050-57	60W	100-277V AC	1050mA	57V	± 5%	< 1%	85%	114.2x75.5x28mm
CDCP-60-1400-42	60W	100-277V AC	1400mA	42V	± 5%	< 1%	85%	114.2x75.5x28mm

\* Output current can be customized

## CDCM-60 Series



**100-277V AC**  
Input Voltage

**50/60Hz**  
Input Frequency

**40/60W**  
Rated Power

- PINNACEL Tri-Mode Dimming Constant Current Drivers
- Compatible with TRIAC (forward-phase or leading-edge) / ELV (reverse-phase or trailing-edge) and 0-10 V dimmers
- TRIAC and ELV dimming only at 120 Vac
- Dimming range:5-100%
- Safety standard: EN61347-1, EN61347-2-13, UL8750+1310 CAN/CSA C22.2 No.250.13
- FCC CFR Title 47 Part 15
- EMI standard: EN55015
- EMS standard: EN61547
- ERP: EU2019/2020
- Protection:Short Circuit/Overload/Over Voltage/Over Temperature
- 100% full load burn in test
- Auto restart after remove of fault conditions
- RoHS Compliance



### Dimensions (mm)

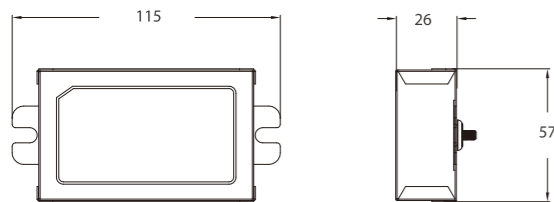

### Constant Current

Model	Power (max.)	Input Voltage	Output Current	Output Voltage (max.)	Voltage Tolerance	Ripple (P-P)	Efficiency	Dimensions (LxWxH)
CDCM-60-0650-46	30W	100-277V AC	650mA	46V	± 5%	< 1%	85%	115x57x26mm
CDCM-60-0700-42	30W	100-277V AC	700mA	42V	± 5%	< 1%	85%	115x57x26mm
CDCM-60-0900-55	50W	100-277V AC	900mA	55V	± 5%	< 1%	85%	115x57x26mm
CDCM-60-1050-57	60W	100-277V AC	1050mA	57V	± 5%	< 1%	85%	115x57x26mm
CDCM-60-1400-42	60W	100-277V AC	1400mA	42V	± 5%	< 1%	85%	115x57x26mm

\* Output current can be customized

## CDCM-120 Series



**100-277V AC**  
Input Voltage

**50/60Hz**  
Input Frequency

**120W**  
Rated Power

- PINNACEL Tri-Mode Dimming Constant Current Drivers
- Compatible with TRIAC (forward-phase or leading-edge) / ELV (reverse-phase or trailing-edge) and 0-10 V dimmers
- TRIAC and ELV dimming only at 120 Vac
- Dimming range:5-100%
- Safety standard: EN61347-1, EN61347-2-13, UL8750+1310 CAN/CSA C22.2 No.250.13
- FCC CFR Title 47 Part 15
- EMI standard: EN55015
- EMS standard: EN61547
- ERP: EU2019/2020
- Protection:Short Circuit/Overload/Over Voltage/Over Temperature
- 100% full load burn in test
- Auto restart after remove of fault conditions
- RoHS Compliance



### Dimensions (mm)

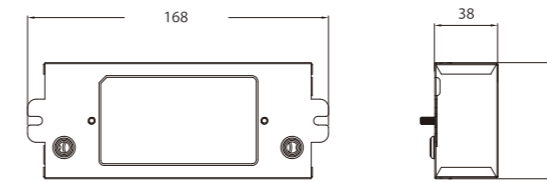

### Constant Current

Model	Power (max.)	Input Voltage	Output Current	Output Voltage (max.)	Voltage Tolerance	Ripple (P-P)	Efficiency	Dimensions (LxWxH)
CDCM-120-0700-85	60W	100-277V AC	700mA	85V	± 5%	< 1%	85%	168x67x38mm
CDCM-120-1400-42	60W	100-277V AC	1400mA	42V	± 5%	< 1%	85%	168x67x38mm
CDCM-120-1400-57	80W	100-277V AC	1400mA	57V	± 5%	< 1%	85%	168x67x38mm
CDCM-120-1050-84	90W	100-277V AC	1050mA	84V	± 5%	< 1%	85%	168x67x38mm
CDCM-120-2100-45	100W	100-277V AC	2100mA	45V	± 5%	< 1%	85%	168x67x38mm
CDCM-120-2700-42	120W	100-277V AC	2700mA	42V	± 5%	< 1%	85%	168x67x38mm

\* Output current can be customized



**Model: YEL50**

Rated Power: 50W  
Input: 100-240V AC 50/60Hz  
Protection: Short Circuit, OCP OVP  
Output: 5-48V  
Dimension: 99x82x30mm



**Model: YEL200**

Rated Power: 200W  
Input: 100-240V AC 50/60Hz  
Protection: Short Circuit, OCP OVP  
Output: 5-48V  
Dimension: 179x99x30mm



**Model: YEL75**

Rated Power: 75W  
Input: 100-240V AC 50/60Hz  
Protection: Short Circuit, OCP OVP  
Output: 5-48V  
Dimension: 99x97x30mm



**Model: YEL350**

Rated Power: 350W  
Input: 100-240V AC 50/60Hz  
Protection: Short Circuit, OCP OVP  
Output: 5-48V  
Dimension: 215x115x30mm



**Model: YEL100**

Rated Power: 100W  
Input: 100-240V AC 50/60Hz  
Protection: Short Circuit, OCP OVP  
Output: 5-48V  
Dimension: 129x97x30mm



**Model: YEL450**

Rated Power: 450W  
Input: 100-240V AC 50/60Hz  
Protection: Short Circuit, OCP OVP  
Output: 5-48V  
Dimension: 215x115x30mm



**Model: YEL150**

Rated Power: 150W  
Input: 100-240V AC 50/60Hz  
Protection: Short Circuit, OCP OVP  
Output: 5-48V  
Dimension: 159x97x30mm



**Model: YEL600**

Rated Power: 600W  
Input: 100-240V AC 50/60Hz  
Protection: Short Circuit, OCP OVP  
Output: 5-48V  
Dimension: 241x106x39.7mm



**Model: YSI 20**

Rated Power: 25W  
Input: 90-264V AC 50/60Hz  
Optional Backup Battery  
Protection: Short Circuit, OCP, OVP  
Output: 5-48V  
Dimension: 98x58x37mm



**Model: YSI 150**

Rated Power: 150W  
Input: 90-264V AC 50/60Hz  
Optional Backup Battery  
Protection: Short Circuit, OCP, OVP  
Output: 5-48V  
Dimension: 160x98x42mm



**Model: YSI 36**

Rated Power: 60W  
Input: 90-264V AC 50/60Hz  
Optional Backup Battery  
Protection: Short Circuit, OCP, OVP  
Output: 5-48V  
Dimension: 110x78x37mm



**Model: YSI 200**

Rated Power: 200W  
Input: 90-264V AC 50/60Hz  
Optional Backup Battery  
Protection: Short Circuit, OCP, OVP  
Output: 5-48V  
Dimension: 200x110x50mm



**Model: YSI 80**

Rated Power: 100W  
Input: 90-264V AC 50/60Hz  
Optional Backup Battery  
Protection: Short Circuit, OCP, OVP  
Output: 5-48V  
Dimension: 130x98x40mm



**Model: YSI 240**

Rated Power: 240W  
Input: 90-264V AC 50/60Hz  
Optional Backup Battery  
Protection: Short Circuit, OCP, OVP  
Output: 5-48V  
Dimension: 200x110x50mm



**Model: YSI 120**

Rated Power: 120W  
Input: 90-264V AC 50/60Hz  
Optional Backup Battery  
Protection: Short Circuit, OCP, OVP  
Output: 5-48V  
Dimension: 160x98x42mm



**Model: YSI 360**

Rated Power: 360W  
Input: 90-264V AC 50/60Hz  
Optional Backup Battery  
Protection: Short Circuit, OCP, OVP  
Output: 5-48V  
Dimension: 215x115x50mm

# Workshops & Equipment



Automatic Injection  
Molding Workshop



SMT Workshop

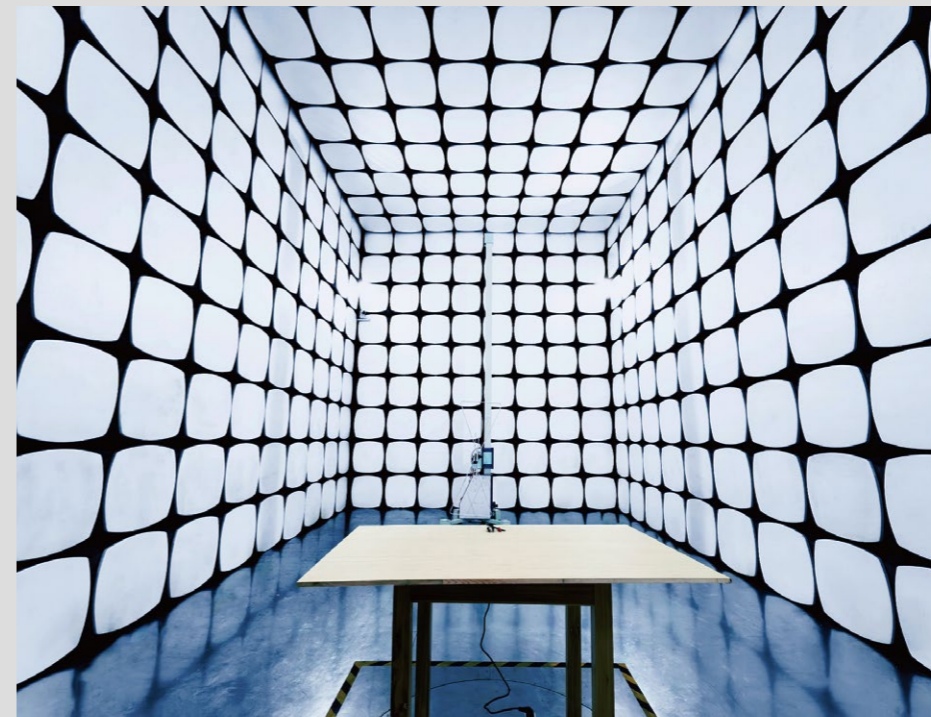

Transformer Automatic  
Assembling Workshop

EMC Lab



Testing & Verification Center



Automatic Encapsulating Workshop



DIP Workshop



Automatic Aging Test Workshop